

12-2016

# Examination of Pseudomonas fluorescence as a Recombinant Expression Host: Cloning, Expression, and Chromatography

Ahmed K.Ali Elmasheiti  
University of Arkansas, Fayetteville

Follow this and additional works at: <http://scholarworks.uark.edu/etd>

 Part of the [Biological Engineering Commons](#), [Biotechnology Commons](#), and the [Molecular Biology Commons](#)

---

## Recommended Citation

Elmasheiti, Ahmed K.Ali, "Examination of Pseudomonas fluorescence as a Recombinant Expression Host: Cloning, Expression, and Chromatography" (2016). *Theses and Dissertations*. 1802.  
<http://scholarworks.uark.edu/etd/1802>

This Dissertation is brought to you for free and open access by ScholarWorks@UARK. It has been accepted for inclusion in Theses and Dissertations by an authorized administrator of ScholarWorks@UARK. For more information, please contact [scholar@uark.edu](mailto:scholar@uark.edu), [ccmiddle@uark.edu](mailto:ccmiddle@uark.edu).

Examination of *Pseudomonas fluorescens* as a Recombinant Expression Host: Cloning,  
Expression, and Chromatography

A dissertation submitted in partial fulfillment  
of the requirements for the degree of  
Doctor of Philosophy in Cell and Molecular Biology

by

Ahmed K. Ali Elmasheiti  
Al-Arab Medical University  
Higher Diploma in Medical Laboratory Technology, 1991  
Al-Arab Medical University  
Post-Graduate Diploma in Medical Laboratory Science, 1996  
Al-Arab Medical University  
Master of Science in Medical Microbiology, 2004

December 2016  
University of Arkansas

This dissertation is approved for recommendation to the Graduate Council.

---

Dr. Robert R. Beitle  
Dissertation Director

---

Dr. Christa Hestekin  
Committee member

---

Dr. Ralph Henry  
Committee member

---

Dr. Joshua Sakon  
Committee member

## ABSTRACT

In an effort to expand the pool of bacterium useful for biotechnology applications, *Pseudomonas fluorescens*, a common gram negative microbe, was examined for its ability to function in a recombinant setting. *P. fluorescens* is ubiquitous in nature and was initially identified as a soil bacterium found in dirt and is typically associated with plant material. Past literature indicates that it shared characteristics common to *Escherichia coli* and *Bacillus subtilis*, including simple growth conditions and potential cloning vectors, providing motivation to look into both the upstream and downstream characteristics of this bacterium. First, it was demonstrated that *P. fluorescens* could be grown to acceptable cell densities in simple batch with cell weights on the order of 60 g/L in the absence of optimization. Lysates of cells were subjected to DEAE ion exchange chromatography to identify the subproteome of soluble proteins which are retained by this resin to guide cellular modifications that reduce the amount and number of host cell proteins (HCPs) encountered during bioseparation. Finally, cloning experiments with Green Fluorescent Protein and FC fragment of tetanus demonstrated both moderate- and large- recombinant DNA products may be obtained from this host.

## ACKNOWLEDGEMENTS

First of all, I would like to thank my God who guides me in the biological science and gives me the ability to achieve my dream.

Foremost, I would like to express my sincere gratitude to my advisor Professor Bob Beitle for the continuous support, and also his motivation, enthusiasm, patience, and tremendous knowledge. His guidance helped me throughout the research and writing of this thesis. I could not have imagined having a better advisor and mentor for my Ph.D study.

I would like to thank my committee members; Professor Joshua Sakon, Professor Ralph Henry, and Professor Christa Hestekin for their notes and comments. Specifically, when I defended my candidacy about the design of a new DNA amplifier device, the committee provided valuable questions and comments. Additionally, I thank Professor Christa Hestekin for writing a successful proposal about the device, which allowed the work to continue. My sincere thanks also go to Dr. Mackenzie Fruchtl, Dr. allen Brune, and Dr. Tammy Rechtin who gave me their experiences and their unlimited help during I was doing my research.

In addition, I would like to send acknowledgement to my country Libya and wish for peace to spread through it soon so I may participate in the development of the biological sciences by teaching advanced courses and researching.

Last but not the least; I would like to say to my wife that I have nothing without you.

## TABLE OF CONTENTS

<b>1. Overview</b> .....	1
<b>2. Background</b> .....	2
2.1 Proteome.....	2
2.1.1 Human.....	2
2.1.2 Bacteria.....	4
2.2. Biotechnology and bioprocesses.....	6
2.2.1 Polymerase Chain reaction (PCR).....	7
2.2.1.1 Primers.....	8
2.2.1.2 Melting temperature (T <sub>m</sub> ).....	8
2.2.1.3 Percent of guanine and cytosine (G+C %).....	9
2.2.1.3 Principle of PCR.....	9
2.2.1.4 Denaturation.....	10
2.2.1.5 Annealing.....	10
2.2.1.6 Elongation.....	10
2.2.2 Batch fermenter (bioreactor) .....	10
2.2.2.1 Simple batch.....	11
2.2.2.2 Fed batch.....	12
2.2.2.3 Continuous.....	12
2.2.3 Ion exchange chromatography (IEXC).....	13
2.2.3.1 Principle of IEXC.....	14
2.2.3.2 Effect of mobile phase composition.....	15
2.2.3.3 Hydrogen ion concentration (pH).....	15
2.2.3.4 Salt concentration.....	16
2.2.3.5 Ion exchange resins.....	16
2.2.3.5.1 Natural organic resins.....	16

2.2.3.5.2 Synthetics inorganic resins.....	16
2.2.3.5.3 Synthetic organic resins.....	17
2.2.4 Polyhistidine tags (affinity chromatography).....	17
2.2.5 Proteome identification and mass spectrometer.....	19
2.2.5.1 Mass spectrometer.....	19
2.2.6 Gene cloning.....	20
2.2.6.1 Plasmid.....	22
2.2.6.1.1 Multiple cloning sites (MCS).....	24
2.2.6.1.2 Selection markers.....	24
2.2.6.1.3 Inducible promoters.....	25
2.2.6.1.4 Ribosomal binding site (RBS).....	26
2.2.6.1.5 Other features.....	26
2.3 Vaccines.....	26
2.3.1 Live attenuated vaccines.....	27
2.3.2 Inactivated vaccines.....	27
2.3.3 Toxoids.....	27
2.3.4 Recombinant subunit vaccines.....	28
2.3.4.1 Structure and mechanism tetanus neurotoxin (TeNT).....	28
2.3.4.2 Cloning and expression of FC fragment.....	32
2.4 Pseudomonads.....	32
2.4.1 Whole-genome sequence of <i>Pseudomonas</i> spp.....	33
2.4.2 <i>P. fluorescens</i> .....	34
2.4.2.1 Metabolism.....	37
2.4.2.2 Transportation.....	38
2.4.2.3 <i>Pseudomonas fluorescens</i> and expression technology.....	38
2.4.3 <i>P. fluorescens</i> vs <i>E. coli</i> .....	38
<b>3. Scope of the research.....</b>	<b>40</b>

<b>4. Materials and Methods</b> .....	41
4.1 Preparation of <i>P. fluorescens</i> .....	41
4.2 Antibiotic sensitivity tests.....	41
4.3 Batch cultivation.....	42
4.4 Extraction of intracellular proteins by sonication.....	43
4.5 Proteins purification by FPLC.....	43
4.6 Determination of total <i>P. fluorescens</i> proteins.....	44
4.7 Proteins separation by SDS-PAGE.....	44
4.8 Preparation and run of the protein samples in the gel.....	45
4.9 Design and construct pAEM-1 from pBBR1mcs-3 and pGFPuv.....	45
4.10 pBBR1mcs-3.....	45
4.11 Green fluorescence protein plasmid (pGFPuv).....	46
4.12 pAEM-1.....	47
4.13 PCR technique.....	49
4.14 Agarose gel electrophoresis.....	49
4.15 Cloning of pAEM-1.....	50
4.16 Transformation of pAEM-1 to <i>E. coli</i> .....	50
4.17 Plasmid recovery.....	51
4.18 Transformation of pAEM-1 to <i>P. fluorescens</i> by electrophoresis.....	52
4.19 Design of His-6 tag containing FC.....	53
4.20 Construction of pAEM-2-His6-FC.....	55
4.21 Detection of His6 Tag-FC protein.....	55
4.22 Transformation of pGFPuv to <i>E. coli</i> and <i>P. fluorescens</i> .....	56
4.23 Restriction of GFP gene from pGFPuv using <i>XbaI</i> and <i>Apal</i> restriction enzymes.....	56
<b>5. Results and discussion</b> .....	57
5.1 Selection of tetracycline marker.....	57
5.2 Confirmation transform of pGFPuv to <i>P. fluorescens</i> .....	58

5.3 Cultivation of <i>P. fluorescens</i> by batch fermenter.....	59
5.4 Total chromosomal proteins of <i>P. fluorescens</i> .....	59
5.5 Elution with respect to GFPuv.....	64
5.6 Construction of pAEM-1 containing green fluorescens gene.....	66
5.7 Purification of GFP expressed by <i>P. fluorescens</i> .....	68
5.8 Restriction of His×6-FC by <i>XbaI</i> and <i>ApaI</i> from dam <i>E. coli</i> .....	69
5.9 Detection of His×6-FC by protein tag stain reagent set.....	71
<b>6. Conclusion.....</b>	<b>72</b>
<b>7. Recommendations.....</b>	<b>73</b>
<b>8. References.....</b>	<b>74</b>
<b>Appendix I.....</b>	<b>85</b>
<b>Appendix II.....</b>	<b>101</b>



## LIST OF FIGURES

Figure 2-1: The four levels of protein structure.....	4
Figure 2-2: Types and application of proteomics on different biological fields.....	6
Figure 2-3: Steps and temperatures of each PCR cycle.....	9
Figure 2-4: Two types of ion exchange chromatography.....	14
Figure 2-5: Principle of column chromatography.....	15
Figure 2-6. Interaction of histidine to both nickel- nitriloacetic acid (1) and cobalt- carboxymethylaspartate (b).....	18
Figure 2-7: Four derivatives of pBBR1MCS.....	23
Figure 2-8: Diagrammatic representation of tetanus neurotoxin (TeNT).....	30
Figure 2-9: Steps of mechanism of action of tetanus neurotoxin (TeNT).....	31
Figure 2-10: Complete genome sequence of <i>P. fluorescens</i> Pf-5.....	36
Figure 4-1: Batch fermenter for cultivation of <i>P. fluorescens</i> using LB broth.....	42
Figure 4-2: pBBR1mcs-3 plasmid carries many restriction enzyme sites and tetracycline gene.....	46
Figure 4-3: pGFPuv carries <i>XpaI</i> , <i>ApaI</i> , <i>lac</i> promotor, and ampicillin.....	47
Figure 4-4: Construction of a new designed pAEM-1. The plasmid contains GFPuv gene, <i>lac</i> promotor, tetracycline resistance genes and restriction sites for <i>SacII</i> , <i>ApaI</i> , and <i>XbaI</i> .....	48
Figure 4-5: Whole sequence of FC contains <i>XbaI</i> restriction site and His×6 tag sequence.....	54
Figure 4-6. Site of methylation (GATC) between <i>XbaI</i> and His×6 .....	55
Figure 5-1. Kirby-Bauer disk diffusion susceptibility test appears resistance of <i>P. fluorescens</i> to tetracycline.....	58
Figur 5-2. Illumination of pGPF-containing <i>P. fluorescens</i> in broth culture (left) and LB agar (right) under ultraviolet light.....	58
Figure 5-3. DEAE chromatography of <i>P. fluorescens</i> extract.....	60
Figure 5-4. Different bands of protein extracted from samples 7, 8, 9 and 10 on SDS-PAGE extracted from <i>P. fluorescens</i> .....	61
Figure 5-5. Comparison of <i>P. fluorescens</i> extract properties to that of GFPuv.....	65
Figure 5-6. Two separated bands. Lane three shows the whole pGFPuv and the lane 5 shows only <i>lac operon</i> containing GFPuv gene .....	66
Figure 5-7. Agarose gel electrophoresis appears DNA bands of pAEM-1.....	67

Figure 5-8. DEAE chromatography appears high peaks of GFPuv proteins extracted from <i>P. fluorescens</i> .....	68
Figure 5-9. Detection of GFP protein (about 27 KDa) by SDS-PAGE.....	79
Figure 5-10. Lane thee appears whole pUC-His×6FC and lane five appears onle His×6-FC after treated with <i>Apal</i> and <i>Xbal</i> .....	70
Figure 5-11. His×6FC gene showed in lanes 3 and 5 after treated with <i>Apal</i> and <i>Xbal</i> from <i>P. fluorescens</i> and <i>E. coli</i> ; respectively. Lane 7 presents whole His×6FC containing pAEM-2.....	70
Figure 5-12. Electrophoresis of extracts containing His6-FC detected by CCD camera.....	71

## LIST OF TABLES

Table 2-1: Examples of recombinant proteins obtained by bioprocesses.....	21
Table 2-2: General feature of four Pseudomonas genomes. ....	34
Table 2-3: Functional and non-functional genes, repeats and gaps of <i>P. fluorescens</i> chromosome ten cycles. Each cycle the gene clusters are classified by different colors.....	37
Table 5-1: Protein concentrations of samples measured by spectrophotometry.....	61
Table 5-2: Scaffold output.....	62
Table 5-3: The function of fifteen proteins were.....	63

## 1. Overview

This dissertation characterizes the cloning and production of recombinant products using *P. fluorescens* in the long term hope that the vaccine components may be made by this host. Chapter One summarizes the most common techniques applied in molecular biology and biotechnology laboratories in addition to a brief introduction on vaccines. Chapter Two describes the materials and methods that were applied throughout the research to construct two expression plasmids (pAEM-1 and -2) for model recombinant DNA products, and to investigate chromatographic behavior of *P. fluorescent* lysates. Chapter Three provides the results obtained that indicate soluble proteins of interest may be produced by this host cell. Finally, as two appendices and independent to the current work, is a funded proposal sent to the EPA based on my Ph.D. qualifying exam and a report of its findings.

## **2. Background**

### **2.1 Proteome**

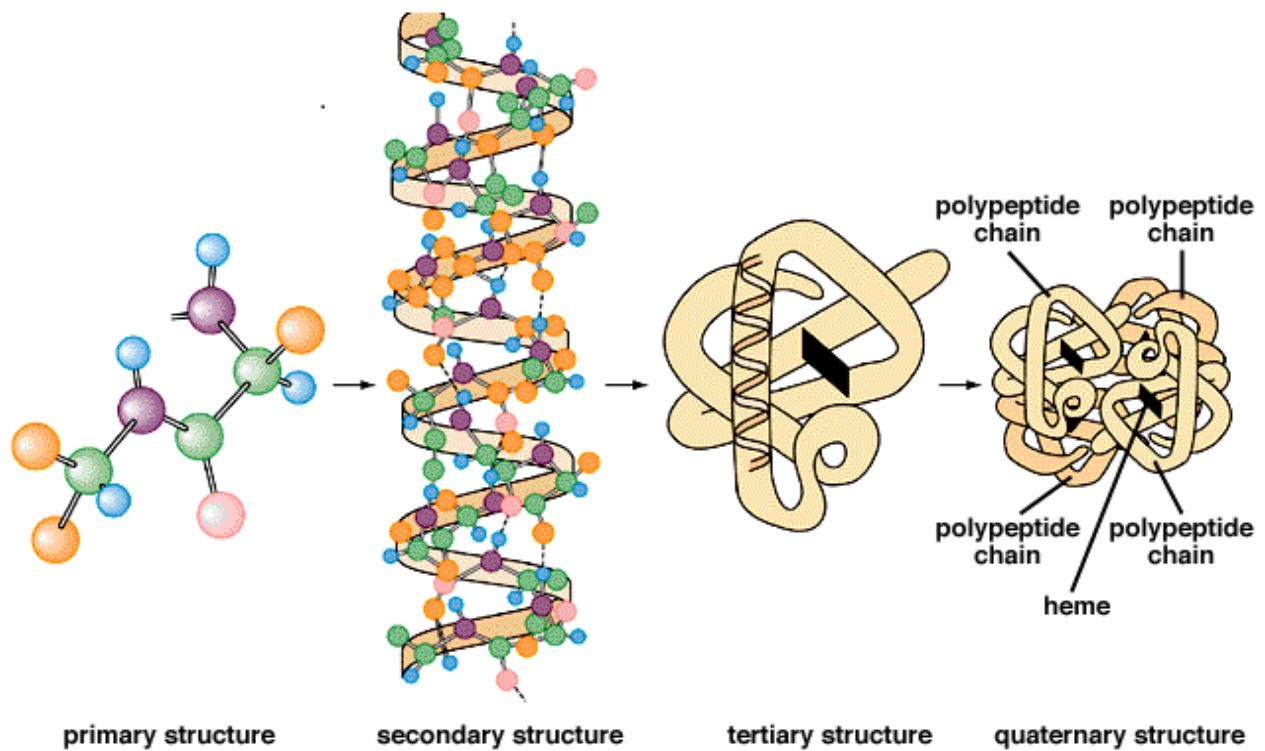
The term *proteome* arose in 1995 and was defined as the comprehensive study of cellular proteins under specific conditions at a given time (Wasinger et al., 1995). The purpose is not only to know their interactions and/or modifications, but also to create a multi-dimension view including time. Knowledge of a proteome requires immense information on molecular biology, biochemistry, and bioinformatics. Normally, cells are undergoing natural and acquired differentiations and are varied in their ages; therefore, they may make or degrade protein(s). For this reason a cell is able to produce an uncountable number of proteins, since the cell is dynamic in nature making it unlike the static behavior of the genome (Eisenberg, Marcotte, Xenarios, & Yeates, 2000).

#### **2.1.1 Human**

Although the total human genome was sequenced (Lander et al., 2001; Venter et al., 2001), it does not give a complete understanding about our DNA. Around 30,000 to 40,000 genes have been recognized in human 23 chromosomal pairs; the function of only 50% of them has been reported. In addition, these genes stimulate only 2% of the DNA of human cells. Most of the remaining 98% genes are considered cryptic remnants of the creation and development of human being (Mrazek, J., and Summers, 2008), which is termed as junk DNA (Nowak, 1994). Another disadvantage of genomics is that it completely fails to describe blood because sera lacks of cells (DNA) but contain proteins. Proteins are responsible for cellular phenotypes; therefore, it is unattainable to interpret disease mechanism and the action of the environment only by genomics,

whereas proteomics can provide characterization of protein modifications and specific drug interactions (Anderson and Seilhamer 1997; Abbott 1999; Gygi et al. 1999).

The study of a proteome (proteomic) appears to be sophisticated. Human proteins are composed of only 20 amino acids which originate by the combination of three out of four nucleotides (guanine, adenine, thymine, and cytosine) in codons. During synthesis, proteins undergo pre- and post-translational modifications to reach the final structure. For many internal and external reasons, sometimes proteins even fail to reach the final step(s) of processing. In this case the cell will alter and become abnormal when compared with the other intact cells. The true example is carcinogenic cells. Proteomics can provide a complete picture of this defect. Consequently, it enables the researcher to diagnosis and treat many types of cancer (Walgren & Thompson, 2004). The other important feature of proteomic studies relates to protein conformation. As shown in Figure 2-1, proteins have four levels of structure (primary, secondary, tertiary, and quaternary). Each scale is crucial to cell function. The primary structure provides a template of information where the secondary-quaternary structures will create a functional 3-dimensional product. Proteomics are able to identify each level and set up a clear snapshot of protein synthesis and the reason(s) for interference of their production and modification (Pierce, Fakhari, Works, Pierce, & Clancy, 2007).



**Figure 2-1. The four levels of protein structure.**

([http://4.bp.blogspot.com/\\_ee2yOd0wTkk/TLfmPbTNEXI/AAAAAAAAAAs/eyaXy8fKMwg/s1600/0048.gif](http://4.bp.blogspot.com/_ee2yOd0wTkk/TLfmPbTNEXI/AAAAAAAAAAs/eyaXy8fKMwg/s1600/0048.gif))

### 2.1.2 Bacteria

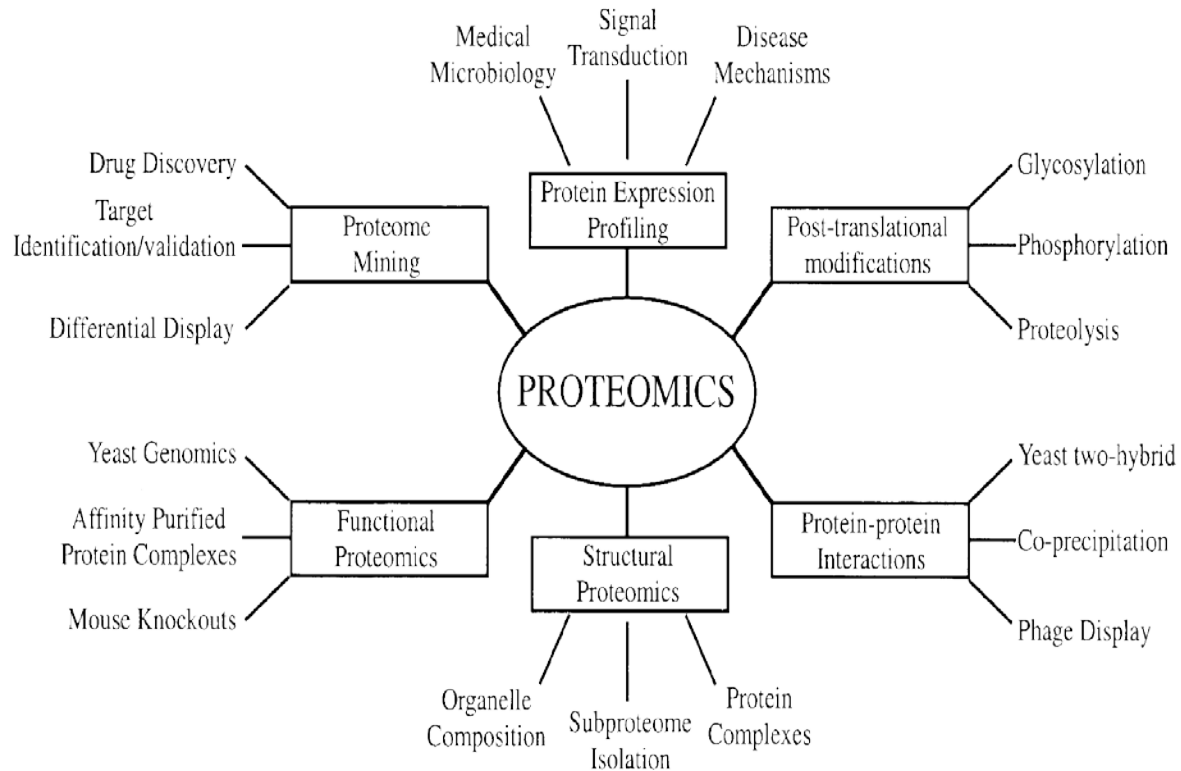
A bacterium as a single cell from an external perspective looks simpler at the proteome level when compared to the aggregate information of millions of different human cells. However, bacterial proteomes are more sophisticated. Bacteria are eligible to achieve mechanisms that are impossible for humans or any other living organisms. For example, bacterial cells can be stored intact at  $-80^{\circ}\text{C}$  for years by a process called cryopreservation (Pegg, 2007). In addition, bacteria live for a period of time that no other organism can tolerate extreme conditions like high or low temperature, dryness, and nutrient deficiency. Furthermore, depending on their metabolic state, pathogenic bacteria cause several diseases for multi cellular organisms; whereas, commensal

bacteria live mutually on and in eukaryotic bodies and inhibit colonization of other bacteria by production of some metabolites (e.g. antibiotics) or by blocking host cell receptors. All of these characteristics and more are controlled by their proteins. At specific conditions, bacteria produce other sets of protein(s). For example, in the absence of oxygen, facultative anaerobic bacteria harness another respiration pathway. This adaptation is regulated by genes, but ultimately is accomplished by synthesis of specific proteins. When compared to humans, most genes in bacterial DNA are coded genes (85%) (Mrazek, J., and Summers, 2008). As mentioned above, only 2% of human genes are coded expressed. Scientists explain this high development in bacteria as they reached perfect maturation during their response and adaptation against environmental changes millions of years ago. It is hypothesized that bacteria lost their genes which are no longer needed (Mrazek, J., and Summers, 2008).

Although proteomics technology has been applied for the last 30 years, demand from pharmaceutical industries has been dramatically increased since the 1990s due to the cooperation between pharmaceutical and bioscience companies. Pharmaceutical industries aspire for drugs characterized by effectiveness, safety, and cost-efficiency. Even though chemically synthetic drugs are broadly used in health centers, medicines based on protein-protein interaction has been more accurate, effective, and lower cost (Pierce et al., 2007).

Information on the bacterial proteome is not limited to use in the medical field. Many other proteins can be synthesized and used for other purposes like in agriculture, food, and detergent industries (De Leo, Panarese, Gallerani, & Ceci, 2009; Kussmann, Panchaud, & Affolter, 2010; Mallick et al., 2007). Figure 2-2, summarizes the benefit of proteomics. All of these fields are affected by understanding how the cell(s) under investigation react to different environmental conditions.





**Figure 2-2. Types and application of proteomics on different biological fields** (Graves & Haystead, 2002).

## 2.2 Biotechnology and bioprocesses

In 1919, a Hungarian engineer, Karl Ereky, proposed that any product obtained from raw substances with the help of living organisms as **biotechnology** (Ereky, 1919; Fári & Kralovánszky, 2006). However, this definition preceded modern techniques neither developed nor applied in the early 1900s. Nowadays, this biological era has evolved enough to permit researchers updated information on, for example, the central dogma, genetic materials, gene mutation, gene transformation, gene isolation and sequencing, functional enzymes, and much other essential information. A Convention on Biology Diversity redefined the term biotechnology as any technological application that uses biological systems, living organisms, or

derivatives thereof, to make or modify products or processes for specific use (Downes, 1993)). The definition is applicable to both traditional and modern biotechnology.

### **2.2.1 Polymerase chain reaction (PCR)**

PCR is considered as the most important and widely used technique by the majority of biological researches. Applications include; diagnosis of hereditary and infectious diseases, gene fingerprinting identification, cloning and annealing pieces of DNA from different origins, and phylogeny (Rahman, Uddin, Sultana, Moue, & Setu, 2013; Valones & Guimarães, 2009). The technique is applied in most biological fields and defined as the artificial replication of DNA (outside the living cells) using thermostable enzymes to create millions of copies from the original single gene in few hours (Saiki et al., 1985). The first application was carried out for diagnosis of human diseases by amplifying the gene associated with the disease. The miracle results obtained from artificial polymerization of the DNA encouraged researchers to develop other practical modifications of PCR such as Inverse PCR (Ochman, Gerber, & Hartl, 1988), Real time PCR (Higuchi, Dollinger, Walsh, & Griffith, 1992), Nested PCR (Haff, 1994), Reverse Transcriptional PCR (Heid, Stevens, Livak, & Williams, 1996), Digital PCR (Pohl & Shih, 2014), and Loop-mediated isothermal amplification (LAMP) (Notomi et al., 2000).

Polymerase chain reaction (PCR) takes place in a small tube with a total mixture volume between 25 to 50 microliters (Saiki et al., 1985). The mixture consists of a target gene, containing DNA strand, in vitro synthesized primers, a heat tolerance polymerase enzyme, nucleotides, and other substances like magnesium and potassium chloride which provide a suitable environment for enzyme reaction during polymerization. The tube is put in an automatic adjustable thermocycler machine that heats and cools the mixture at predetermined times and

temperatures. The most important facet of PCR is the correct design of the primers for the reaction to be successfully carried out. Therefore, I will give primers more discussion with respect to other substances in the reaction mixture.

### **2.2.1.1 Primers**

Primers are designed to anneal with specific locations within a long sequence of DNA. In traditional PCR, there are two primers-forward and backward- that anneal to the beginning and end of the DNA template; respectively. Primers can be short in length, ranging from 18 to 25 bp. The target double stranded DNA first is denatured into two single strands as a result of high temperature then the temperature is immediately dropped to anneal the primers. Once annealed, the temperature is raised around 10°C above the annealing temperature and the polymerase starts adding, one by one, nucleotides that complement the target DNA (adenine=thymine, and guanine≡cytosine) to synthesize a new double stranded DNA strand. Primers are characterized by parameters such as guanine + cytosine (G+C) content and melting temperature (T<sub>m</sub>). Designing and synthesis of primers are available in silico (computer software). There are many websites that calculate G+C% and T<sub>m</sub> like (<http://www.ncbi.nlm.nih.gov/tools/primer-blast/>, <http://www.bioinformatics.nl/cgi-bin/primer3plus/primer3plus.cgi>, and <http://www.primerdesign.co.uk/home>).

### **2.2.1.2 Melting temperature (T<sub>m</sub>)**

It is defined as the temperature at which half of double stranded DNA disassociates into two single strands. The two primers should be designed to have a similar T<sub>m</sub>, with T<sub>m</sub> between 52 °C to 58 °C to achieve the best yields. If the T<sub>m</sub> is too low, other undesired fragments of DNA are polymerized resulting in different bands when gel electrophoresis is run. In contrast, when



#### **2.2.1.4 Denaturation**

It is also called DNA melting. During 20-30 seconds the reaction is heated to reach 94-96°C. Hydrogen bonds that connect double DNA strands are broken and the strands are separated into two single strands. Polymerase is heat resistant; therefore, it will not deactivate due to high temperature.

#### **2.2.1.5 Annealing**

In this step the temperature is reduced to 50-65°C for 20-40 seconds to allow primers to anneal. This step is very important and the  $T_m$  of the primers should be between 3-5°C above the annealing temperature to avoid self-loop formation of the single strand.

#### **2.2.1.6 Elongation**

As soon as the primers anneal the DNA template, the temperature is raised to 72-78°C where DNA polymerase starts adding dNTPs to primer/ template complex directed from 5' to 3' to form a new double stranded DNA. Typically, polymerase is able to incorporate 1-1.5 thousand bases per minute (kb/min) (Joshi & Deshpande, 2011).

#### **2.2.2 Batch fermenter (Bioreactor)**

It is a closed system used to generate high yield of a desired product(s) by increasing the culture cell density in liquid medium in the presence of growth requirements (Nedović & Willaert, 2004). The technique is mostly applied to certain genetically engineered bacterial cells in the research laboratories or food, biomedical and pharmaceutical industries. Comparing with traditional flask growth, a bioreactor has many advantages. In flask, growth condition cannot be controlled. For example, oxygen concentration dwindles with time resulting in low growth rate

of the bacteria (Lloyd & Bunch, 1996). In the absence of oxygen, facultative anaerobic bacteria such as *E. coli* will employ anaerobic pathways leading to the synthesis of different end products that may inhibit or block the production of the desired protein (Tseng & Montville, 1992). Another motive is the concentration of the hydrogen ion (pH) (Wunschel et al., 2005). Most bacteria utilized in the laboratories or industries have an optimum pH. In shaker flask, pH drops with time due to secretion of acids produced by fermentation of carbohydrates-containing media by the bacteria to create ATP. Acidic environment is toxic to the bacteria and also may have an effect on the desired protein (Wunschel et al., 2005).

A bioreactor controls and stabilizes oxygen concentration and pH. All three types of bioreactors are supplied by oxygen, monitor pH, and are connected to computerized software that read and change, automatically, the oxygen delivery or agitation to maintain dissolved oxygen, and the acid/base addition to control pH.

#### **2.2.2.1 Simple batch**

A batch is simple, meaning that all components (media, bacteria, substrates) are added at the same time (Godbey, 2014). The technique is easy to operate, inexpensive and the chance of contamination is very low. It is widely used in academic laboratories to improve yield from bacterial, mammalian and insect cells. In the genetic engineering field, bacterial cells are transformed with a plasmid containing the DNA for a certain protein. The cells are transferred to a sterile glass vessel or tank containing suitable media and substrate(s) and closed tightly with a head plate containing stirrer extended down close to the bottom of the vessels. The head plate has slots to connect an oxygen supply, pH electrode, dissolved oxygen and temperature probes. Software adjusts oxygen flow rate, maintenance of pH (e.g. sodium hydroxide), optimum heat,

and the speed of the stirrer. During the experiment, a few drops of antifoam are aseptically added to prevent foam formation which has an adverse effect on the rate of oxygen transfer (Etoc, Delvigne, Lecomte, & Thonart, 2006). Typically, induction of the gene expression is carried out at the early part of the exponential phase where the optical density ( $O.D_{600}$ ) is about 0.6 and the process is ended between five to seven hours later. Batch bioreactor lasts more days when compared to flask shaker. However; the device and all parts have to be cleaned and sterilized after each experiment which is time consuming and considered the only disadvantage.

#### **2.2.2.2 Fed batch**

The main differences between batch and fed batch technique are the inducer and/or substrate(s) is (are) added at intervals. In some cases, the substrate or the expressed protein can be toxic to the cells when present in large amount; therefore, the inducer added in a small amount at different times. The fed batch last days longer than batch and the quantity of the desired protein can be high. In addition, growth rate of the cells is controllable; subsequently; high cell density can be achieved. The disadvantages of fed batch are equipment expense and calculating the time of adding substrate and the time of induction (Korz, Rinas, Hellmuth, Sanders, & Deckwer, 1995).

#### **2.2.2.3 Continuous**

They are industrial type and used for commercial products. Like fed batch, the substrate is added continuously; however, the products are also removed. The volume output can be huge and the process can last long times. The system is more complicated, expensive and the chance of contamination is more than the previous techniques (Páca & Grégr, 1976).

### 2.2.3 Ion exchange chromatography (IEXC)

Although many physical and chemical techniques exist for protein separation and purification, biological molecules need more advanced procedures to achieve the perfect separation and high degree of purification. In fact, separation of proteins from a mixture requires more than one technique because after cell lysis, other contents (DNA, RNA, lipids, sugars, etc.) are liberated. Therefore, proteins have to be isolated and purified to high integrity and quality. Application of chromatographic systems (chroma = color and graphein = to write) are required.

Chromatography belongs to a group of separation techniques involving the retention of material with minimal effect on their biological nature. Chromatography systems are widely used because they are simple and produce highly purified products. Column chromatography, for instance, is simply described as a solid stationary phase packed in a column, with a liquid mobile phase passing through. Speed of passing mobile phase determines the degree of adsorption (Eith, Kolb, Seubert, & Viehweger, 2001).

Ion exchange probably is the most frequently used technique for purification of proteins. During separation, protein can maintain its native conformation because the process occurs under mild conditions. The system also shows very high specific binding capacity. In contrast, non-specific adsorption due to hydrophobicity is very low. Additional motives for the success of IEXC include consistent and flexible conditions (Eith et al., 2001). IEXC works to separate biological molecules via attraction between opposite charges of stationary phase and protein. In the beginning of the last century, a synthetic stationary phase consisting of hydrophilic polymer matrix was manufactured, with substituted ionic materials to follow. Unfortunately, the hydrophobicity characteristics of the matrix caused proteins to lose their natural composition.



This problem was solved in 1950 by applying a hydrophilic matrix. Currently there are many types and sizes of IEXC matrices (Srikanth, Sunil, Rao, Uhumwangho, & Ramana Murthy, 2010).

### 2.2.3.1 Principle of IEXC

Ion exchange is defined as an attraction of particles that carry different charges. Amino acids, for example, have ampholytic properties so they may appear as acidic or basic. Consequently, it will attract oppositely with charges that reside on the stationary phase. On the other hand, it will repulse completely when the stationary phase is loaded with the same charge (Rathore & Pinky, 2012).

The stationary phase contains ionic functional groups which attract oppositely charged analytes. Exchanger chromatography can be anion exchange chromatography when the column is loaded with positive charge; thereby, retaining the negative charge from the sample. Or; it can be cation exchange chromatography when the positive charge in the sample attracts negative charges to the packing (Fig. 2- 4 and Fig. 2.5) (Rathore & Pinky, 2012).

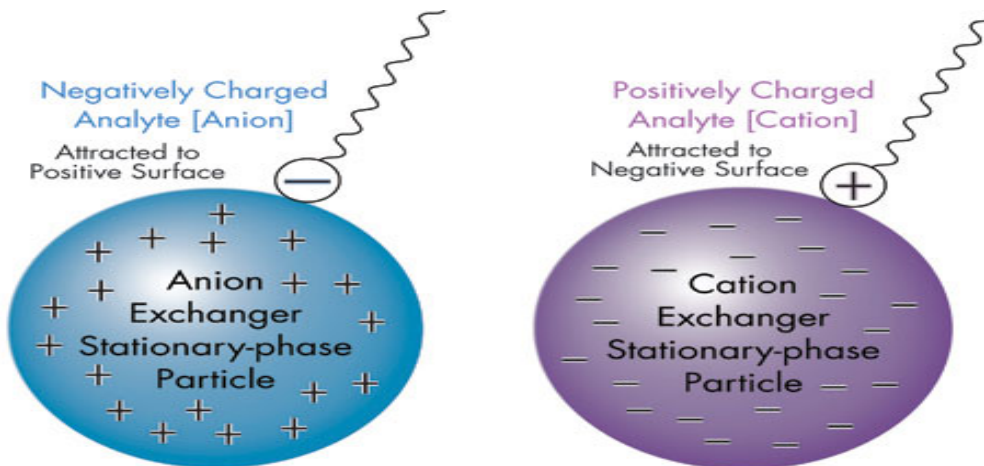


Figure 2-4. Two types of ion exchange chromatography (Rathore & Pinky, 2012).

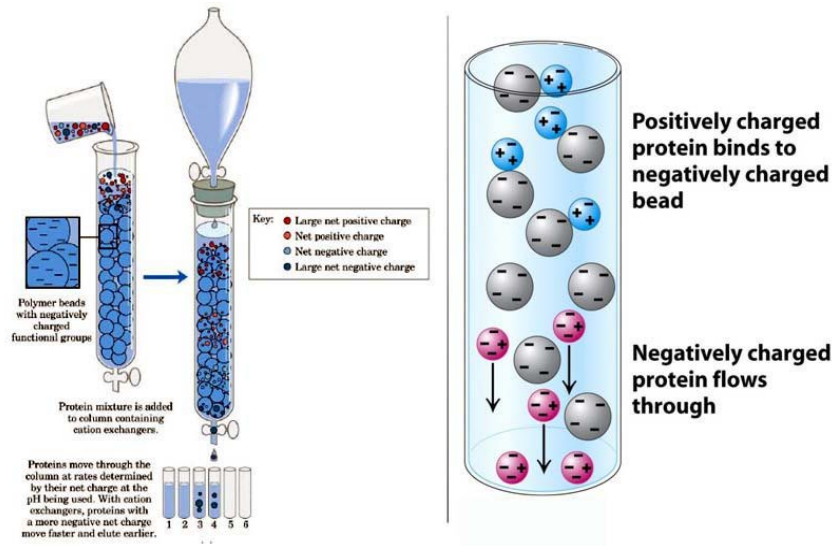


Figure 2-5. Principle of column chromatography (Rathore & Pinky, 2012).

### 2.2.3.2 Effect of mobile phase composition

Choosing the mobile phase for the separation of biomolecules through IEXC is an essential step. Though many factors should be regarded, the hydrogen ion concentration (pH) and the salt concentration are the most important factors (Yu et al., 2003).

### 2.2.3.3 Hydrogen ion concentration (pH)

Choosing of the pH is a fundamental factor in IEXC. In view of the fact that the pH sets the charge of the mobile phase and the stationary phase, the affinity of adsorbent is dictated by an increase or decrease of the pH value. Any mobile phase should have a suitable buffer to fit the pH range. Common buffers provide wide ranges of pH and include tris, phosphate, citrate, and acetate. In IEXC, the selection of buffer for isolation of macromolecules like proteins is not as easy as choosing a buffer for a sample molecule. In tertiary protein structure, only the outer amino acids participate in separation process, as the inner amino acids remain undetectable.

#### **2.2.3.4 Salt concentration**

The binding between charged substances is interrupted by increasing the salt concentration.

Complex molecules with multi structures can be separated entirely by optimizing the concentration of salt gradients of the buffer. In general, a salt gradient concentration from 0M to 1M brings a desirable isolation.

#### **2.2.3.5 Ion exchange resins**

Various resins are characterized by wide range of exchange capacity. Ion exchange resins are categorized into three groups according to their source and nature (Rathore & Pinky, 2012).

##### **2.2.3.5.1 Natural organic resins**

Substances such as cotton and coal are able to become a cationic exchange by phosphorylation or sulphorylation. They work as a cation exchanger because upon attachment of a sulphonic acid or carboxylic group the material is negatively charged. The disadvantage of these materials is their limitation in separation process because they are affected by other chemicals and also have polymorphic structures.

##### **2.2.3.5.2 Synthetic inorganic resins**

This type of resin consists of a three dimensional structure of connected channels from inside. It acts as cation exchanger for the presence of hydrous oxide of tetravalent and tri metals.

Examples of these materials are alumino-silicates,  $TiO_2$ , phosphate etc. (Yu et al., 2003).

### 2.2.3.5.3 Synthetic organic resins

Synthetic organic resins are made of a network of cross linked polymer. This structure enables the resin to possess many functional groups. They also have the ability to act as cation or anion exchanger. In the cationic format, they contain an acid group like sulfonic acid, whereas in an anionic column they carry a basic group like quaternary ammonium.

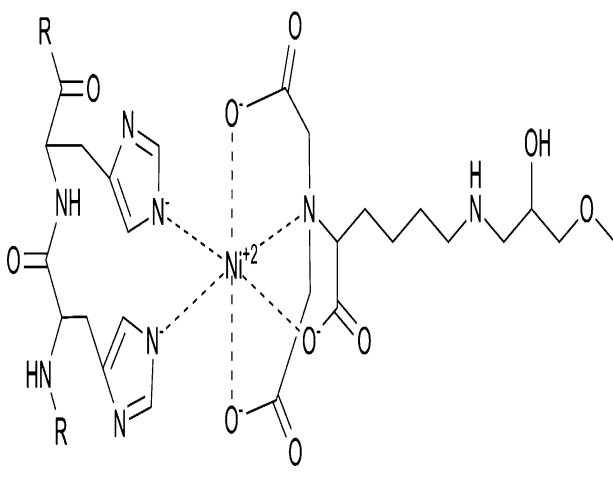
### 2.2.4 Polyhistidine tags (affinity chromatography)

It is a powerful method that can yield high purification, up to 95% of a target recombinant protein(s) from a crude mixture (Hochuli et al. 1988; Janknecht et al. 1991). Unlike ion exchange chromatography which depends on opposite charge interaction, purification by polyhistidine tag occurs due to affinity of certain metal ions with certain amino acids (Dong et al. 2010).

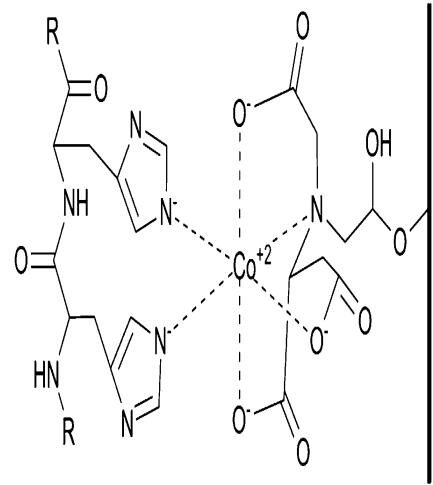
Therefore, it is also known as Immobilized Metal Affinity Chromatography (IMAC). Histidine has the strongest affinity interaction with immobilized metal ions such as cobalt, copper, and zinc (all +2 charge). The principle of the affinity is simple: histidine has an imidazole ring which forms pi interaction bond with the metal ions (Crowe et al. 1994) . Figure 2-6 shows the commercially preferred matrixes nickel-nitrilotriacetic acid ( $\text{Ni}^{2+}$ -NTA) (Hochuli, Döbeli, & Schacher, 1987) and cobalt-carboxymethylaspartate ( $\text{Co}^{2+}$ -CMA) (Chaga, Hopp, & Nelson, 1999). Deploying a His6 affinity tag not only acts as a purification helper, but also as an expression marker since antibodies to His6 are available. For the expression of genetically engineered recombinant proteins, the gene is extended with a sequence of six codons of histidine (CAT and CAC) at either the 5' or 3' terminus. After the gene is cloned in a vector (e.g. plasmid) and transformed in host cell (e.g. bacteria), the host expresses and produces the desired protein extended by six histidine residues (in addition to other undesired proteins). When the crude

sample (mobile phase) is loaded and passed through a column containing one of the above immobilized metal ions (stationary phase), the protein “tagged” with histidine is covalently bound via imidazole ring, whereas, others are washed out. While other host proteins can bind to the immobilized metal ions, conditions (pH, salt concentration, presence of free imidazole) favor his-tagged proteins. This is the reason for IMAC’s ability to deliver 95% purity in a single step.

(a) His-tag--Ni<sup>2+</sup>--NTA



(b) His-tag--Co<sup>2+</sup>--CMA



**Figure 2-6. Interaction of histidine to both nickel- nitriloacetic acid (a) and cobalt-carboxymethylaspartate (b).**

The relatively short tail of histidine residues normally does not affect the target protein activity and does not require removal after purification (Crowe et al., 1994). However, the tag can be removed easily by inserting a protease cleavage site between the his-tag and the protein. The elution of a target protein is achieved either by adjusting the pH or adding free imidazole to the column buffer (Porath, 1992).

### **2.2.5 Proteome identification and mass spectrometer**

The function of a protein is connected completely to its three dimensional structure; therefore, recognizing the structure of a given protein or polypeptide is substantial. In recombinant expressed proteins, the nucleic acids are known, genomic sequence translates and provides clear information about composition. For an unknown expressed proteins, however, it is difficult to study the proteome using only structure information as the twenty amino acids, except methionine and tryptophan, have more than codon.

Information obtained from the three dimensional structure protein by modern nuclear magnetic resonance spectroscopy (Wüthrich, 2001) or x-ray crystallography (Scapin, 2006) when combined sequencing by mass spectrometry techniques (Finehout & Lee, 2004) can offer complete information. This information is useful for many fields, providing data on genetic disorders, recognition of gene mutation, interaction of toxins and antitoxins, the function of each part of the protein, and whole or specific parts of a gene-related protein in other organisms. In biological laboratories, amino acid sequencing of expressed proteins are achieved by mass spectrometry technique.

#### **2.2.5.1 Mass spectrometry**

The technique has been developed to become the most trustful procedure in sequence and identification; not only the amino acids, but any charged molecules; even though, present at very low concentration in a mixture. The molecules that are present in a solid or a liquid mixture is ionized and converted into gas phase where the ratio of ionized ion to its charge ( $M/Z$ ) can be calculated. Matrix-assisted laser desorption/ionization (MALDI) (Karas & Hillenkamp, 1988; Tanaka, Waki, & Ido, 1988) and electrospray ionization (ESI) (Fenn, Mann, Meng, Wong, &

Whitehouse, 1989) are the common techniques applied in the identification of charged molecules.

The principle of mass spectrometry depends on three major steps: evaporation, analysis, and detection. However before these steps, the three dimension protein structure undergoes denaturation (Finehout & Lee, 2004). The sample is heated to evaporate, and then pushed through a vacuum column containing an electrical field. One electron hits the analyte molecule resulting in displacement of out one electron to become a positive charged ion which interacts with negatively charged field (Finehout & Lee, 2004). The newly formed ions pass through a mass analyzer such as time-of-flight (TOF) where they are distinguished by their mass to charge ratios. The smaller ions are traveling faster than larger ones, meaning the smaller ions require less time to pull through the chamber (Finehout & Lee, 2004). Software that contains all time required for each amino acid is used to measure the travelling time and by comparing the outcome with saved data, peptides can be determined allowing one to assemble the protein in silico for identification (Finehout & Lee, 2004).

### **2.2.6 Gene cloning**

In the middle of the last century, Watson and Crick in 1953 opened a new era for biotechnology when they visualized the DNA, determined its pairing rules (adenine=thymine, guanine=cytosine), and shape (double strands) (Watson & Crick, 1953). This discovery has lead scientists to recognize structure, function, isolation and sequencing of those genes. Products could be vaccine components, hormones, enzymes, drugs, antibiotics, or essential elements for the living organism itself or for others. Table 2-1, shows a sample of products obtained by biotechnology.

**Table 2-1. Examples of recombinant proteins obtained by bioprocesses.**

	Protein	Function
1	Three different derivatives of the green fluorescent protein (GFP), namely enhanced cyan (ECFP), enhanced green (EGFP), enhanced yellow (EYFP), and the recently published red fluorescent protein (Bloemberg et al. 2007).	Cloning markers
2	Granulocyte colonystimulating factor (G-CSF) (Jin et al., 2011).	Drug candidate
3	Cowpea Chlorotic Mottle virus-like particle (VLP) (Phelps et al. 2007).	Vaccine conjugates
4	Protective antigen (rPA) (Wu et al., 2010).	Anthrax vaccine candidate
5	Alanine racemase (Ju et al. 2005).	Peptidoglycan biosynthesis
6	CRM <sub>197</sub> (Bromuro et al., 2010).	Diphtheria toxoid
7	Other recombinant toxoid proteins (Diane et al. 2011). Pertussis Toxin, Tetanus Toxoid Fragment C (FC), and Cholera Toxin B	Vaccine components
8	Cry34Ab1 and Cry35Ab1 proteins (Gao et al., 2004).	Protect corn against rootworm damage
9	d-endotoxin cryIA(c) (Peng et al. 2003).	Insecticidal activity against most larvae of Lepidoptera spp.

Modern biotechnology can provide highly purified, safe, and cheap products because desired gene products can either found using software that mines databases like NCBI, or through the sequence data for a new product, or both. Instead of using true toxins derived from a pathogenic organism, for example, biotechnologists first sequence the toxin and construct the gene *in silico*. This gene manipulation technique is defined as genetic engineering. The technique, in brief, requires the synthesis of specific genes flanked by primers that have endonuclease restriction sites complementary to sequences present in a defined vector (i.e. plasmids). The restriction enzymes will open the vector so the target gene is added through the process of ligation (Nicholl, 2008). The vector is then introduced into a nonpathogenic-laboratory defined bacterial host (Hill



et al., 1994; Motamedi, 2011), cultured in suitable media to multiply, and eventually used to produce large quantities of protein(s). The final step is to extract, isolate, and purify the products.

### **2.2.6.1 Plasmid**

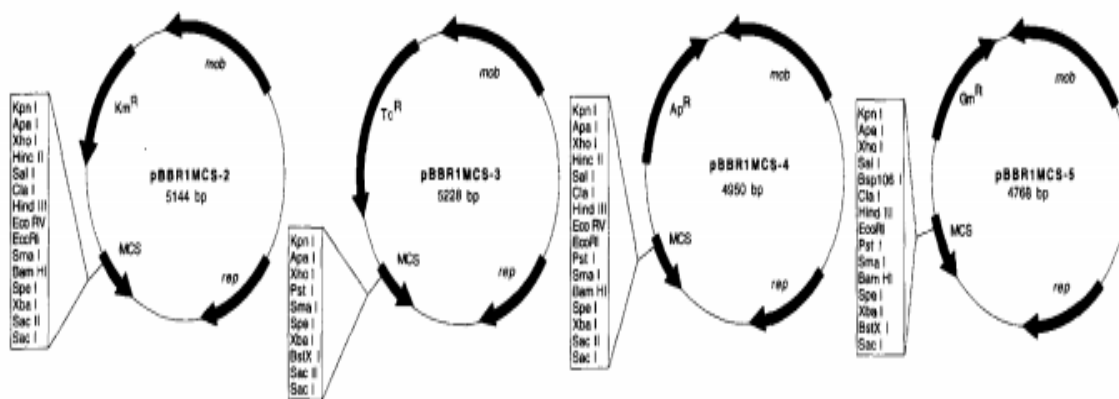
Historically, the first articles describing the successful recombinant-DNA replication and recombinant protein production was back in the early 1970s (Cohen et al. 1973; Jackson et al. 1972). The reports hypothesized the possibility of cutting a piece of a DNA by specific enzymes called restriction enzymes and annealing it in another foreign DNA by ligation. However, the first true usable recombinant process was the manufacture the insulin hormone which was designed by Johnson in 1983 and licensed by Eli Lilly and Company (Johnson, 1983). The process, like most require the plasmid.

A plasmid is a cloning vector used to insert a foreign gene(s) in prokaryotic and eukaryotic cells. It is defined as a small circular piece of double stranded DNA that has the ability to replicate autonomously inside the host cells. In nature, a plasmid can be taken by living cells and the latter will possess a new trait. For instance, when a bacterium takes a beta lactamase gene-containing plasmid it becomes resistance to the antibiotic ampicillin. At the same time, the plasmid may have certain genes and express a desired protein such as drugs (insulin), vaccines (tetanus toxoid), nutrients ( $\beta$ -carotene), and detergent (lipase) (Keen et al. 1980), (Motamedi, 2011), (Paine,2005), and (Fairweather & Lyness, 1986; Jørgensen, Skov, & Diderichsen, 1991); respectively.

Similar to bacteriophages and cosmids, plasmids can be genetically manipulated, cloned, and maintained in a host cells. The first experiments in transformation of engineered plasmid were achieved in the beginning of 1970s using *E. coli* as a host (Cohen et al., 1973; Jackson et al.,

1972). *E. coli* still preferred host for expression of recombinant proteins in most laboratories and companies.

Plasmids have different sizes ranging from few thousand to hundred thousand base pairs. Small sized plasmids are transformed in small living cells like bacteria and the large ones for eukaryotes such as yeast and plant cells. Every engineered plasmid has its own name that distinguishes it from others. Some plasmids have derivatives; each one has a specific character like one derivative providing a resistance gene for antibiotic whereas the other derivative carries a resistance gene for a different antibiotic. In this case, the derivatives may be distinguished by numbers. For example, Figure 2-7, illustrates five subclasses of pBBR1 plasmid (Kovach et al. 1995; Obranić et al. 2013).



**Figure 2-7. Four derivatives of pBBR1MCS.** Each one is carries by carrying a different antibiotic resistance gene, and multiple cloning site (Kovach et al., 1995).

Plasmids are also selected upon the function of the target protein as some plasmids replicate and produce hundreds of copies inside one bacterial cell (pUC19 produces 500 – 700 copies/cell) (Vieira & Messing, 1982). Subsequently, expressing large amount of a desired protein occurs because of the gene dose. However, in certain circumstances we use low copy number plasmids

when the expressed protein has toxic activities similar to antibiotics that may kill the bacterial cell when produced. The induction of toxic protein can also be controlled by using tightly regulated promoters such as arabinose-inducible (Khlebnikov et al. 2000) rather than leaky expression promoter as IPTG-inducible (Marbach & Bettenbrock, 2012). The recombinant plasmid has to have features to be able to cloned, transformed and expressed, as described in the next three subsections.

#### **2.2.6.1 Multiple cloning sites (MCS)**

They are the sites where recombinant genes or ligated and removed from the plasmid in the directed fashion. Multiple cloning sites (MSC) carry sequences which correspond to different restriction enzymes. Each enzyme cuts at specific sequence (e.g. *SacII* for CCGCGG and *ApaI* for GGGCCC). Before the investigators design a gene, they need to know the MCS of the candidate plasmid. Typically they select two restriction sites sequences, one for forward and the other for reverse, to force a direction for the insertion. The whole gene is polymerized (multiplied) by PCR to produce a large number of copies. Two endonuclease enzymes are applied to the plasmid to cut or open it. When the engineered gene is added, it will fit precisely in the plasmid and the phosphodiester bond sealing the sequence will be catalyzed by DNA ligase. The plasmid is restored to its circular conformation. Finally, the modified plasmid is transformed into the host cells to produce the desired proteins.

#### **2.2.6.1.2 Selection markers**

Not all living cells desire to host a plasmid. For instance in bacteria, only one cell out of thousands maintain a plasmid even when using artificial cloning by chemicals, heat shock, or electroporation. Selectable markers, which are mostly antibiotic resistance genes, enable

biotechnologists to make sure the host cell accepts and keeps the plasmid. Bacteria will show visible colonies on agar containing an antibiotic, meaning colonies accepted the plasmid containing the resistance gene for this antibiotic. The most widely used antibiotic is ampicillin. Plasmids carrying a beta lactamase gene will inhibit the action of ampicillin by breakdown the beta-lactam bond.

### 2.2.6.1.3 Inducible promoters

Inducible promoters are DNA sequences located in the 3' direction prior to the gene(s) of the target protein. The function of the promoter is to initiate and control expression (transcription). Promoters such as the *lac* promoter are induced only in the presence of a chemical trigger, the disaccharide lactose. Genes controlled by the *lac* promoter are repressed by repressor protein but when lactose is available, it binds the inhibitor, and the *lac* promoter becomes “unlocked” and starts transcription. Subsequently, mRNA for the desired gene is produced. Expression of genes controlled by the native *lac operon* results in breakdown of lactose's beta galactosidase bond to glucose and galactose (Kennell & Riezman, 1977). Accumulation of acids in the growth medium drops the pH and this acidic mix can become toxic to the bacterial cells like *E. coli*. The alternative isopropyl  $\beta$ -D-1-thiogalactopyranoside (IPTG) inducer has the same effect on the *lac* promoter, yet it does not get catabolized via metabolic pathways (Marbach & Bettenbrock, 2012). Thereby, the pH of the medium is maintained at the same range.

#### **2.2.6.1.4 Ribosomal binding site (RBS)**

The RBS is an important feature of a mRNA sequence, the properties of which are dictated by DNA sequence between the operator and the start of the desired gene. Ribosomes have different affinity for each RBS; therefore, translation can be affected by mRNA sequence where they bind.

#### **2.2.6.1.5 Other features**

There are additional features of a plasmid which provide blue-white or similar selection, ease of sequencing pre-defined sequences for fusion of affinity tags like His6, product localization, soluble enhancement, and inclusion body formation. These are mentioned for completeness and are not described in detail (Ghrayeb et al., 1984; Lerner & Inouye, 1990).

### **2.3. Vaccines**

Vaccines are biochemical substances given to living organisms to stimulate their immune response against certain infectious diseases, mainly bacteria and viruses. There are several recombinant vaccines and different methods used to obtain vaccines characterized by their specificity, effectivity, purification, and safety.

Before modern bioprocesses had been developed, the production of a vaccine depended on inactivation of the infectious agent or its toxic products. Inactivation was carried out mostly by repeat culturing of the virulent microbe or by treating the toxins with chemicals that alter their activity. Live attenuated and inactivated vaccines are examples of traditional techniques. Those two techniques have disadvantages (discussed in next paragraphs) which could not be overcome until modern biological techniques were applied. Highly characterized recombinant vaccines

such as toxoids and subunit vaccines are, recently, expressed and purified in large quantities by more advance techniques using other nonpathogenic bacteria (Sanghi & Tiwle, 2014)

### **2.3.1 Live attenuated vaccines**

These vaccines are used mainly against viral infections. The manufacture of live attenuated vaccines depends on repeating culture of the pathogenic virus for around 200 generations in one cell type (e.g. chick cells). In this case, the virus is accommodated, begins to replicate better and better in these cells during repeating passage, yet it loses the ability to replicate in different host cells like human cells due to mutation. At the same time, the virus is still able to stimulate a human immune response. After the attenuated vaccine is taken by human (mouth or injection), the acquired immunity will developed and the person becomes protected. The disadvantage of a live attenuated product is the fact that the attenuated virus may mutate and becomes more virulent, rendering the repeated culturing ineffective (Minor, 2015).

### **2.3.2 Inactivated vaccines**

The infectious agent is inactivated by heat or chemicals. Subsequently, it forfeits its replication ability but is kept intact enough to be recognized by the human immune system. Inactivated vaccines usually are given to visitors to place where certain infectious diseases are predominant because the vaccine offers only a short period of protection unless another booster is taken.

### **2.3.3 Toxoids**

Toxoids are inactive form of the toxins. Inactivation is done by treating the toxins with chemicals like nitrosoguanidine. In case of diphtheria toxoid, treatment with chemicals resulted in mutation in glycine at position 52 which is substituted by glutamic acid. The substitution leads to loss of

toxin activity while still preserving the ability to stimulate a response. This toxoid is known as CRM 197 (cross reacting materials) (Giannini, et al. 1984).

Toxoids are used not only against its original virulence form of the toxin, but also as a carrier agent when conjugated with lipopolysaccharides or endotoxins of pathogenic bacteria such as *Haemophilus influenza* and *Neisseria meningitides* (Habermehl & Leroux-Roels, 2010). This type of vaccine is called a conjugated vaccine. Note that removal of chemicals that are used for conversion of a toxin to toxoid, as well as, other bacterial material and conjugation reactants require more purification processes that may affect the yield of the final product.

#### **2.3.4 Recombinant subunit vaccines**

Sequencing of the DNA associated with a toxin enables the scientists to recognize and assign the function of all parts of the toxin. For instance, there will be parts that function only to attach to a specific structure on the host cell. Others open the cell membrane, block some mechanism, alter host DNA, etc. Subunit vaccines depend on recognition of part(s) of the toxin responsible for the (first few) steps causing the disease; at the same time, is recognizable by the host immune system. This part or subunit is given to the host. The host will develop immunity against part and becomes immunized against whole the toxin because, in case of infection, immune cells will respond rapidly and prevent the first step(s) of the toxin mechanism. Subunit vaccines can be obtained by either isolation of a functional piece directly from the toxin or artificially by synthesis *in vitro* (Andersson, 2000).

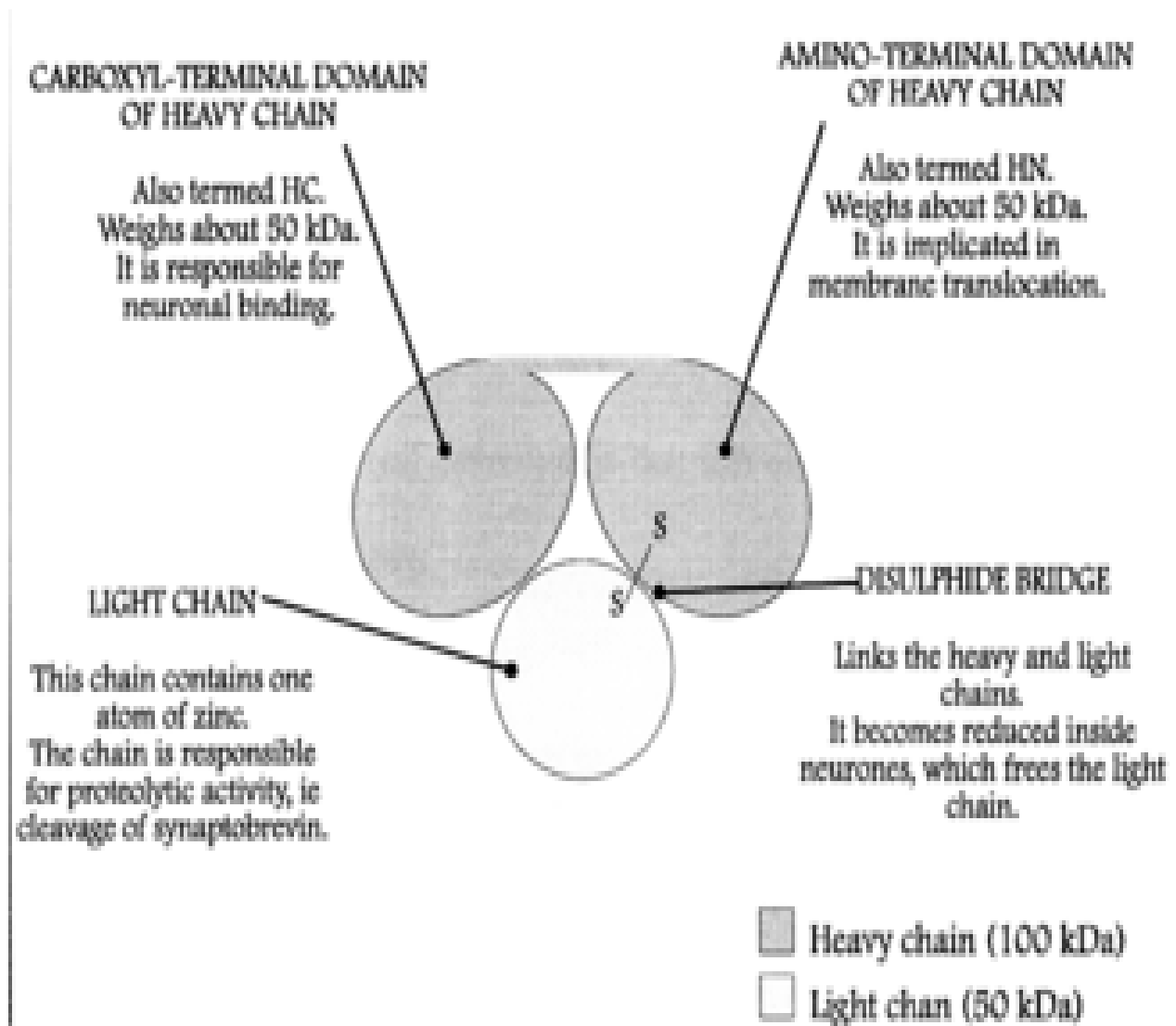
##### **2.3.4.1 Structure and mechanism of tetanus neurotoxin (TeNT)**

Tetanus disease is now very rare in developed countries due to successful application of vaccines. However, WHO annually records new cases, in particular neonatal tetanus, in

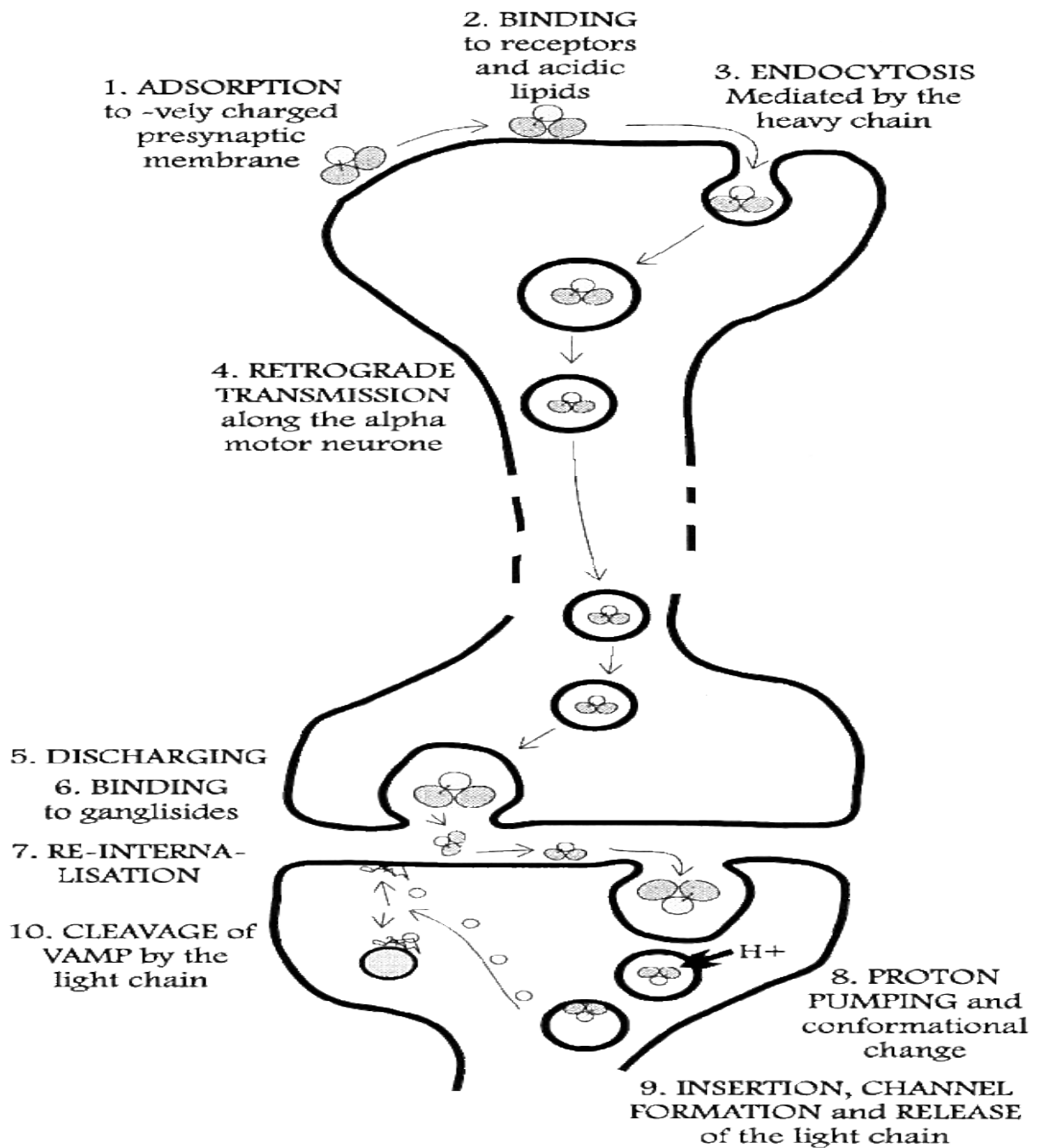
developing countries (Blencowe, Lawn, & Vandelaer, 2010; Liu et al., 2014). The disease is caused by extracellular tetanus neurotoxin (TeNT) secreted by *Clostridium tetani*. The toxin inhibits neurotransmitters when bound and can enter certain ganglioside cells present in nervous tissues (Herrerros et al. 2000).

Tetanus neurotoxin (TeNT) consists of a 150 KD single polypeptide chain. After TeNT is expressed, a clostridial protease cleaves it into 100 KD heavy chain (the targeting and the translocation domains) and 50 KD light chain (the catalytic domain) linked by a disulphide bond (Herrerros et al., 2000). Heavy chain is also cleaved by papain protease to yield two fragments, the heavy C fragment (FC fragment) and heavy N fragment (Fig. 2-8). FC fragment is responsible for TeNT binding to the ganglioside cell membrane (Baldassi, 2005; Fitzsimmons, Clark, Wilkerson, & Shapiro, 2000). Deletion mutagenesis studies demonstrated that FC retains binding activity of intact TeNT. Light chain enters into the gangliosides and inhibits neurotransmitter function after heavy chain (Fig. 2-9). Hence, neurotoxicity of light chain can be inhibited by the blocking of FC binding site.





**Figure2-8. Diagrammatic representation of tetanus neurotoxin (TeNT).**  
 (<https://en.wikipedia.org/wiki/Tetanospasmin>).



**Figure 2-9. Steps of mechanism of action of tetanus neurotoxin (TeNT).**  
 (<https://en.wikipedia.org/wiki/Tetanospasmin>).

#### **2.3.4.2 Cloning and expression of FC fragment**

Tetanus toxoid is the inactive form of tetanus toxin prepared by chemical alteration (mutation) of the whole toxin. While it still is applied as a vaccine, it has the disadvantage of irritation at the site of injection, risk of toxicity, and variable immunity (Motamedi, 2011). Therefore, recombinant technology such as cloning and expression of FC fragment has been investigated. It has been reported that recombinant FC subunit gives greater and safer protection against tetanus when compared to the tetanus toxoid (Medaglini et al., 2001).

FC is non toxigenic and has only binding capacity, yet it strongly stimulates the host immune response, i.e. a human (or an animal). When injected with only FC, a person becomes protected against future tetanus attack. Previous reports showed full-scale expression and production when recombinant FC is cloned and expressed in *E. coli* using various combinations of plasmid, cell line, promoter, and affinity tag (Fairweather & Lyness, 1986; Halpern et al. 1990; Motamedi, 2011).

#### **2.4 Pseudomonads**

The genus of pseudomonas contains species with much functional diversity. However, all are ubiquitous and live mainly in water, soil, and plant surfaces (Hirano & Upper, 2000). The genus belongs to  $\gamma$ -proteobacteria which is gram negative rods, motile, aerobic and is able to produce cytochrome oxidase enzyme. Cytochrome oxidase catalyzes the oxidation of cytochrome *c* and reduces oxygen to form water (Parr et al. 1974). Production of cytochrome oxidase enzyme is the main feature that differ *Pseudomonas spp* from other gram negative enterobacteriaceae, especially when clinical laboratories are providing identification.

Pseudomonades produce a number of secondary metabolites similar to antibiotics which enhance their survival and lifestyle, protect the hosts (plants) from pathogens, and thereby coexist in commensal relationships. The simplicity of growth requirements and the ability to adapt and produce a variety of metabolites, suggest that pseudomonas strains can serve as hosts for the cloning of a recombinant gene (Haas & Keel, 2003). However, to date few reports of using this species to produce recombinant products exist in literature.

#### **2.4.1 Whole-genome sequence of pseudomonas spp**

The first whole-genome sequence was carried out in *P. aerogenosa* PAO1 (Stover et al., 2000), followed by *P. putida* (Nelson et al., 2002), *P. syringea* (Buell et al., 2003), *P. fluorescens* (Paulsen et al., 2005), *P. entomorphila* (Vodovar et al., 2006), and *P. stutzeri* (Yan et al., 2008). According to the sequences, the genome sizes are between 4.6 and 7.1 Mb. Out of them, the predicted genes are from 4237 to 6396 and the G+C % contents is from 57.8 to 66.6% (Table 2-2). A comparative genome study on the diversity among *pseudomonas spp* has been reported (Loper et al., 2012) where only 2468 genes were considered as conserved between four *Pseudomonas spp* (*P. aeruginosa*, *P. fluorescens*, *P. syringae*, *P. putida*). Consequently, each strain can exhibit its own metabolome and proteome.

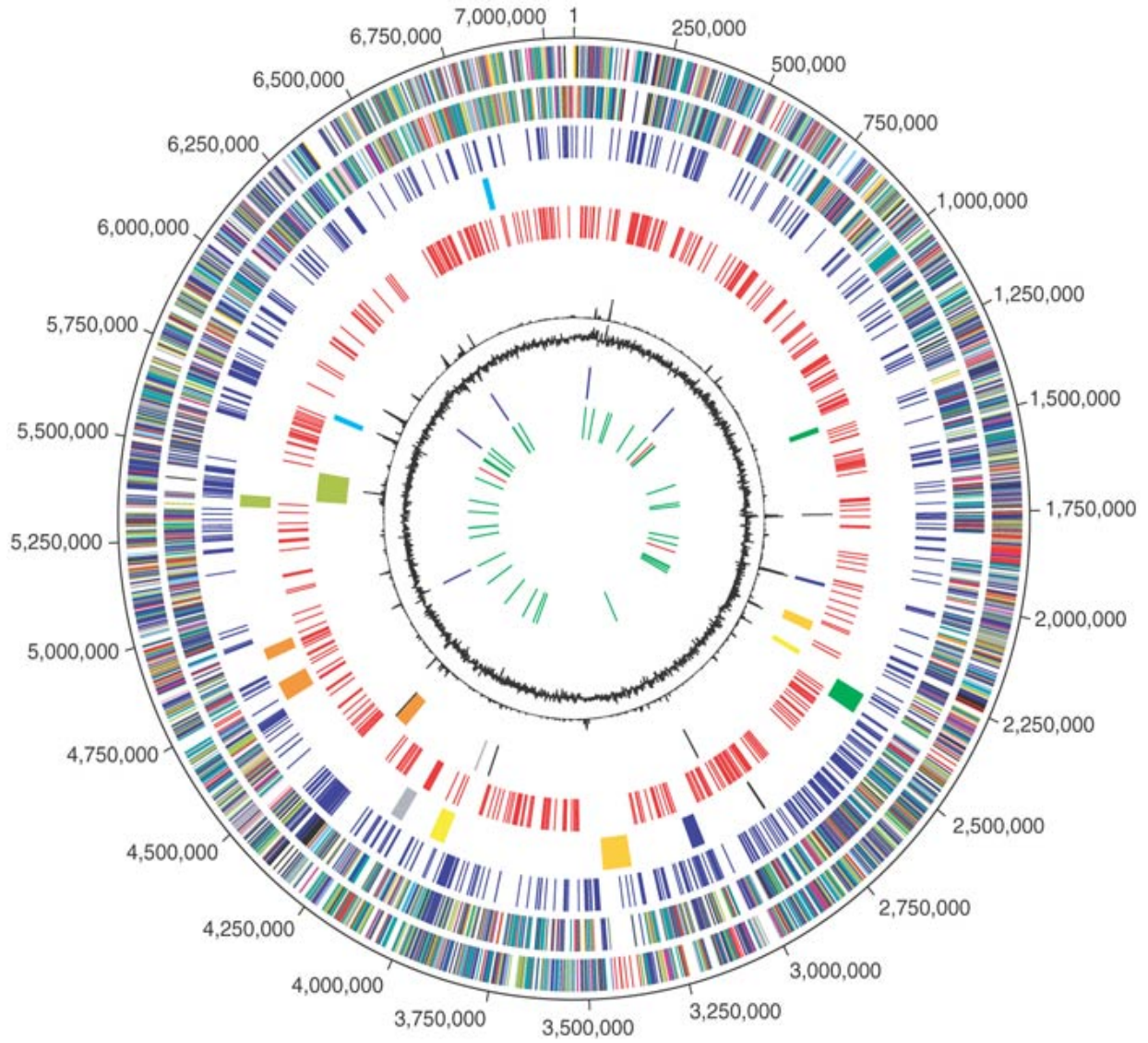
**Table 2-2. General feature of four Pseudomonas genomes.**

	<i>P. fluorescens</i>	<i>P. aeruginosa</i>	<i>P. putida</i>	<i>P. syringae</i>
<b>Size (base pairs)</b>	7,074,893	6,264,403	6,181,863	6,538,260
<b>G+C content (%)</b>	63.3	66.6	61.6	58.4
<b>Protein-coding genes</b>				
No. similar to know proteins	3.822	3.021	3.311	3.524
No. similar to protein of unknown function	890	NA	522	647
No. conserved hypotheticals	1.113	769	995	976
No. with no database match	330	1.780	596	628
<b>Total</b>	6.144	5.570	5.420	5.763
<b>Average ORF size (bp)</b>	1.021	1.005	998	991
<b>Coding (%)</b>	88.8	89.4	88	87
<b>No. different types of rRNA</b>	5	4	7	5
<b>No. different types of tRNA</b>	71	63	74	63

#### 2.4.2 *P. fluorescens*

*Pseudomonas fluorescens* are generally considered as plant flora and were studied for their biocontrol property and their role in promotion of plant growth. According to its biochemical activities and phenotypes, *P. fluorescens* had been divided into multi subspecies (Stanier et al 1966). In recent years, more details especially about evolution and unique metabolites have been studied and reported using modern molecular and genetic tools. Depending on (chromosomal) reports, *P. fluorescens* (pf-5) carries a 7,074,893 bp circular chromosome (Fig. 2-10). Out of them, 88.8% are coding genes. Complete genomic sequence of *P. fluorescens* strains (Paulsen et al., 2005; Silby et al., 2009) showed remarkable rearrangement, gaps, and repeats sequences

(Table 2-3). Genomic sequence, in addition, provides information on their life and environmental adaptation. Paulsen and his coworkers identified nine gene clusters for secondary metabolite in *P. fluorescens* pf-5 strain. Two of them are responsible for siderophores pyoverdine and pyochine biosynthesis. They also recognized one cluster of genes that coded for synthesis of hydrogen cyanide which is comparable to that reported in *P. aeruginosa*. The remaining six are used to produce numerous enzymes for biosynthesis of decapeptide, pyoluteorin, polyketide, and 2,4-diacetylphloroglucinol. The last one is considered as a biocontrol agent because it plays important role as an antifungal and is used by *P. fluorescens* not only to protect itself but to confer immunity to a host plant.



**Figure 2-10. Complete genome sequence of *P. fluorescens* Pf-5 (Paulsen et al., 2005).**

**Table 2-3. Functional and non-functional genes, repeats and gaps of *P. fluorescens* chromosome ten cycles.** Each cycle gene clusters are classified by different colors.

Color/no . circle	1	2	3	4	5	6			
<b>Violet</b>	Biosynthesis of amino acid	Predicted coding region on minus strand	Set of 656 <i>P. fluorescens</i> Pf-5 genes that are not conserved in any of other three pseudomonas genome		REP repeat elements				
<b>Light blue</b>	Biosynthesis of cofactors, prosthetic groups and carries								
<b>Light green</b>	Cell envelope								
<b>Red</b>	Cellular processes								
<b>Brown</b>	Central intermediary metabolism								
<b>Yellow</b>	DNA metabolism							Pyochelin biosynthesis	Prophage 4
<b>Light gray</b>	Energy metabolism								
<b>Magenta</b>	Fatty acid and phospholipid metabolism								
<b>Pink</b>	Protein synthesis and fate								
<b>Orange</b>	Purines pyrimidines, nucleosides and nucleotides							Pyoverdine biosynthesis	Prophage 6
<b>Olive</b>	Regulatory functions and signal transduction							Nonribosomal peptide synthesis	Predicted PFG-1 mobile island
<b>Dark green</b>	Transcription							Decapeptide biosynthesis	Prophage 1
<b>Teal</b>	Transport and binding proteins								
<b>gray</b>	Unknown function							Pyrrolnitrin biosynthesis	Prophage 5
<b>salmon</b>	Other categories								
<b>Blue</b>	Hypothetical proteins		Pyoluteorin biosynthesis	Prophage 2					
<b>Gold</b>			Polyketide biosynthesis	Prophage 3					
<b>cyan</b>			2,4-diacetylphloroglucinol synthesis	Prophage 7					
<b>black</b>				transposases					

### 2.4.2.1 Metabolism

Central biochemical pathways of *P. fluorescens* strains are identical to other analyzed pseudomonads. Genomics showed several extracellular hydrolytic components such as proteases, chitinases, and lipases which are responsible for degradation of polymers normally present in



soil. Furthermore, most amino acids, complex aromatic compounds, and long-chain hydrocarbons can be catabolized by pf-5 strain.

#### **2.4.2.2 Transport**

As the ecological niche of *P. fluorescens* is plants and the major components of seeds and roots are sugars and amino acids, it can breakdown plant carbohydrates and transport sugars via the phosphotransferase transporter system which permits doubling times comparable the other *Pseudomonas spp.* For amino acid transporter, it has been found that *P. fluorescens* contains similar 21 amino acid/polyamine/choline family amino acid transporters found in *P. aeruginosa* and *P. putida*.

#### **2.4.2.3 *P. fluorescens* and expression technology**

As we mentioned above, *P. fluorescens* is able to express different proteins depending on environmental stress. Interesting studies include antifungals (Howell & Stipanovic, 1979; Kraus & Looer, 1992), antibacterials (Raaijmakers et al. 2002), and antinematodals (Siddiqui, Qureshi, Sultana, Ehteshamul-Haque, & Ghaffar, 2000) or promoters such as plant growth promoters (Paulsen et al., 2005). Furthermore, *P. fluorescens* grows rapidly at room temperature on media contain simple nutrients.

#### **2.4.3 *P. fluorescens* vs *E. coli***

Key information indicates *P. fluorescens* can be used as a biological vehicle in the expression and production of recombinant proteins. First, the complete genome is known (Paulsen et al., 2005; Silby et al., 2009), which is important data compiled for any recombinant host or common prokaryote like *E. coli*. During fermentation in bioreactors, the dissolved oxygen can vary in contrast to *E. coli*. Furthermore, *P. fluorescens* is considered as a prototrophic (an organism does

not require organic nutrients and able to synthesis all own metabolites from inorganic elements).  
*Pseudomonas fluorescens* also does not accumulate acetate during growth; subsequently, pH does not substantially decrease nor is this acid at sufficient levels to be toxic (Fersht, 2008).

### 3. Scope of the research

Literature suggests an investigation of the ability for *P. fluorescens* to produce recombinant proteins, eventually leading to widespread adoption of this bacterium as a recombinant host. While it has been suggested that this bacterium could compete with *E. coli* or other simple prokaryotes, laying the groundwork for this to occur has not happened to a significant extent. This study examined the cloning and expression of two proteins in order to demonstrate *P. fluorescens* has potential in this regard. Specifically,

1. A plasmid was constructed that employed IPTG induction for protein expression.
2. The expression of two recombinant products (Green Fluorescent Protein, and FC) was demonstrated.
3. Information about host cell proteins which may be encountered during bioseparation was collected.

## 4. Materials and Methods

### 4.1 Preparation of *P. fluorescens*

*Pseudomonas fluorescens* ATCC949 was purchased from the American Type Culture Collection (ATCC) in lyophilized powdered form. Cultures were cultivated using the most routinely used growth medium named Luria-Bertani (LB) broth and agar because LB medium contains simple nutrient elements enough to supply the bacteria with essential growth requirements such as peptone, yeast extract, and sodium chloride (Bertani, 1951). Half milliliter of Luria-Bertani (LB) broth was added to the powder and gently mixed to dissolve completely. Then 100  $\mu\text{L}$  of the mixture was added to 5 ml of LB and the mixture incubated at 26°C for 17 hours. At the same time, a loopful of mixture (50  $\mu\text{L}$ ) was spread on LB agar and incubated at the same temperature overnight as a backup.

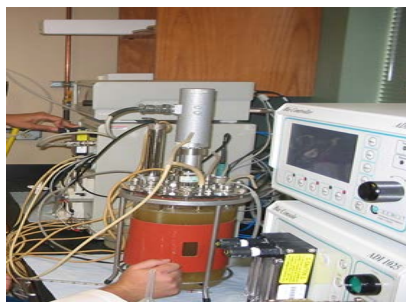
### 4.2 Antibiotic sensitivity tests

Resistance and sensitivity tests against different antibiotics were carried out using Kirby-Bauer Disk Diffusion Susceptibility Test Protocol (Bauer et al. 1966). A loop filled with *P. fluorescens* was spread over LB agar. Paper disks were soaked with various concentrations and types of antibiotics and put over the surface of the agar. After 18 hours, a clear zone of growth inhibition surrounding an antibiotic disk was considered sensitive, whereas, growth around resistant. The antibiotics that tested were according to antibiotic resistant genes carrying in the four derivatives of plasmid pBBR1MCS-2, pBBR1MCS-3, pBBR1MCS-4, and pBBR1MCS-5 which are kanamycin, tetracycline, ampicillin, and gentamycin respectively (Kovach et al., 1995). Additional lower concentration of tetracycline (5  $\mu\text{g}/\text{ml}$ ) was also applied. For transformation of

pAEM2 His6-FC (which carries the ampicillin resistance gene) to *P. fluorescens*, a higher concentration of ampicillin (150  $\mu$ g/ml) was added to LB agar and broth.

### 4.3 Batch cultivations

The purpose of use bioreactor was to obtain a large amount of *P. fluorescens* pellets. Bioreactor system consists of many parts and supplements so all of them must be autoclaved prior to start the work (Fig. 4-1). In the first day, a single colony was transferred to 5 ml LB. broth containing 5  $\mu$ L of tetracycline (stock concentration of 100 mg/10 ml in 75% ethanol) and incubated in a shaker at 26°C for 18 hours (Luo & Farrand, 1999). One ml of culture broth was added to 100 ml of LB broth containing 100  $\mu$ L of tetracycline and incubated for 12 hours to obtain young viable growth ( $O.D_{600} = 0.3 - 0.5$ ). During that time, the condenser and reactor hoses were attached to input/output nozzles on Applikon system. The condenser exhaust was placed in a bottle containing 500 ml of 70% ethanol. By a sterile funnel, 50 ml of culture was transferred to bioreactor flask containing 500 ml of LB broth, 500  $\mu$ L of tetracycline, and a drop of sterile antifoam. The system was set at 26°C, 750 rpm, pH 6.8, and the flow rate at 4 L/ sec. After 10 hours, the optical density of the culture broth was measured hourly by spectrophotometer. The pellets were harvested and collected by centrifugation at 4500 rpm for 40 minutes at 4°C and frozen at -20°C.



**Figure 4-1. Batch fermenter.**

#### **4.4 Extraction of intracellular proteins by sonication**

This simple technique is used to extract protein(s) from inside the bacterial cells. After growth, the pellets were harvested by centrifugation and frozen at  $-20^{\circ}\text{C}$ . One ml of pellets was kept in ice for about 20 minutes to transfer from frozen state to semi liquid state. Immediately, 5 ml of buffer A (25 mM Tris-HCl, pH = 7.9) was added to the pellets. A tip of the sonicator probe was inserted and turned on at full speed for 30 seconds then immediately kept in ice for 30 seconds too. This cycle was repeated five times. The solution was divided into five tubes each and centrifuged for 3 minutes at 14000 rpm and  $4^{\circ}\text{C}$ . Supernatants were then collected and either frozen at  $-20^{\circ}\text{C}$  or used immediately for other work.

#### **4.5 Protein purification by FPLC**

After sonication and release of proteins from the cells, the sample was centrifuged for 4 minutes at 14000 rpm/ $4^{\circ}\text{C}$ . The supernatant (proteins + buffer A) was collected and filtered again with a  $0.2\ \mu\text{m}$  membrane filter.

The chromatography system was first washed with 20% ethanol for 30 minutes at flow rate of 1 ml/min, followed by sterile distilled water for about 2 hours (till the conductivity dropped to zero) at the same flow rate. After that, the entire flow path (e.g. tubes, pumps, channels) was saturated with 100% buffer A (25 mM Tris-HCl, pH = 7.9) at flow rate of 1ml/min for one hour. One ml diethylaminoethyl (DEAE) sepharose column was connected to the machine and washed with buffer A for 30 minutes. Then, mobile phase concentration was adjusted to 50%, which means half of flow would be buffer A and another half would be buffer B (25 mM Tric-HCl and 1000 mM NaCl, pH = 7.9). Three ml of sample was loaded and injected. Purified proteins started to elute and were collected in glass tubes after about 30 minutes.

#### **4.6 Determination of total *P. fluorescens* proteins**

In addition to recording peaks by line chart, we also measured the total protein using Bradford assay with bovine serum as a standard. Twenty microliter of a sample was mixed with 100  $\mu\text{L}$  of reagent A and 800  $\mu\text{L}$  of reagent B. The mixture was incubated at room temperature for 15 minutes, and then read against reagent A and B blank at 750 nm. Calculation of the protein concentration was carried out first in 1 ml as  $(\text{absorbance} - 0.0234) / 0.2659$ , followed by an adjustment for dilution.

#### **4.7 Protein separation by SDS-PAGE**

Isolation of proteins by Sodium Dodecyl Sulphate Polyacrylamide Gel Electrophoresis (SDS-PAGE) depends on their size difference as they move through the gel from negative to positive poles due to the action of an electrical field. For our work, we used 12.5% gel concentration. The gel is composed of two portions, the resolving gel and the stacking gel. According to the technique, the resolving gel was prepared as 1.3 ml 8 $\times$  lower composition buffer, 4.2 ml acrylamide, 1.4 ml 75% sucrose, 4.9 ml  $\text{H}_2\text{O}$ , 6  $\mu\text{L}$  TEMED, and 100  $\mu\text{L}$  5% ammonium persulfate. The resolving gel was poured between two clean glass slides up to three quarters of the height of the cassette. To remove air bubbles, a few drops of butanol were added to the top of the gel. After about 25 minutes, the gel became semisolid and the butanol was decanted.

Stacking gel was prepared nearly the same way where a mixture of 12.5 ml 4 $\times$  upper buffer, 0.75 ml acrylamide, 3.0 ml  $\text{H}_2\text{O}$ , 22  $\mu\text{L}$  TEMED, and 45  $\mu\text{L}$  5% ammonium persulfate was prepared and directly added to the gap above the resolving gel. A comb of 10 teeth was submersed in the top of stacking gel and left for 10 minutes to harden.

#### **4.8 Preparation and run of protein samples in the gel**

First, the protein was denatured by adding 20  $\mu\text{L}$  sample + 100  $\mu\text{L}$  of 1 $\times$  Phosphate-buffered saline (PBS) + 20  $\mu\text{L}$  of 5X sample buffer composition ingredients on side of tube and put in water bath at 95°C for 3 minutes. The comb was removed carefully from the gel and 6  $\mu\text{L}$  of #161-0374 ladder (250 KD) was inserted in the first well and 20  $\mu\text{L}$  of the samples were inserted in the other wells. The gel was put in the electrophoresis chamber and filled with SDS-PAGE buffer (composition). An electrical voltage of 190 V was applied to run the proteins from the negative side to positive one. After about 40 minutes, the gel was transferred to a container filled with Coomassie stain in a mixture of acetic acid and methanol and checked for 15 minutes. The gel was destained by overnight incubation in a mixture of acetic acid and methanol without stain. Protein bands clearly appeared and separated based on their sizes and could be compared to ladder bands.

#### **4.9 Design and construct pAEM-1 from pBBR1mcs-3 and pGFPuv**

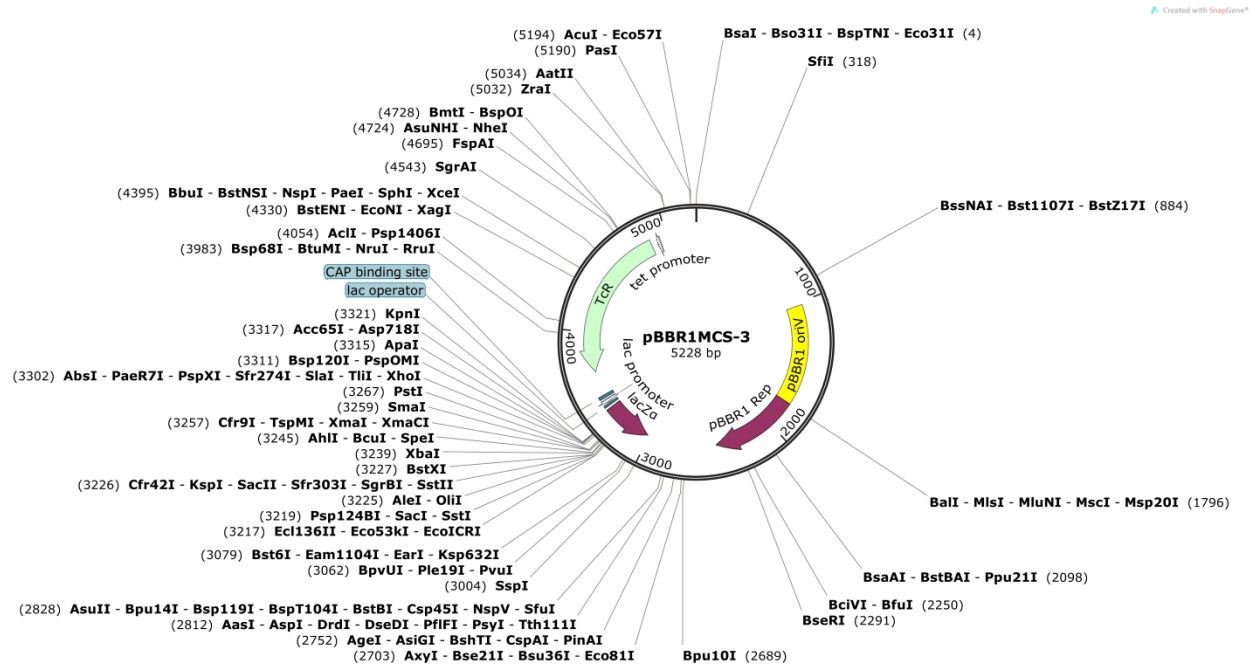
Ahmed Elmasheiti plasmid (pAEM-1) is a new plasmid that contained 5984 bp and was designed to carry characteristics of both pBBR1mcs-3 and pGFPuv, with the addition of *SacII*. The design and PCR are described in detail in the following paragraphs.

#### **4.10 pBBR1mcs-3**

It is the third derivative of five 5228 base pair plasmids provided by Bolivar and Rodriguez (Genbank Accession #U25059) (Kovach et al., 1995; Obranić et al., 2013). The plasmid is characterized by a tetracycline resistance gene, multiple cloning site (MSC), and sites for other restriction enzymes (Fig. 4-2). In its received form, it does not contain any useful DNA for protein overexpression. As it is small in size, it can transfer to prokaryotes simply and possibly



harbor different recombinant genes. In our research, we utilized both *SacII* and *ApaI* to clone the *uv* operon into pBBR1mcs-3. However, the DNA copied from the source (pGFPuv) does not carry restriction site for *SacII*, therefore, we designed *SacII* sequence on forward PCR primer ( $5'$ GATCCGCGGTCCTCCGACTGGAA $3'$ ). For *ApaI* site, fortunately it already existed in both plasmids.

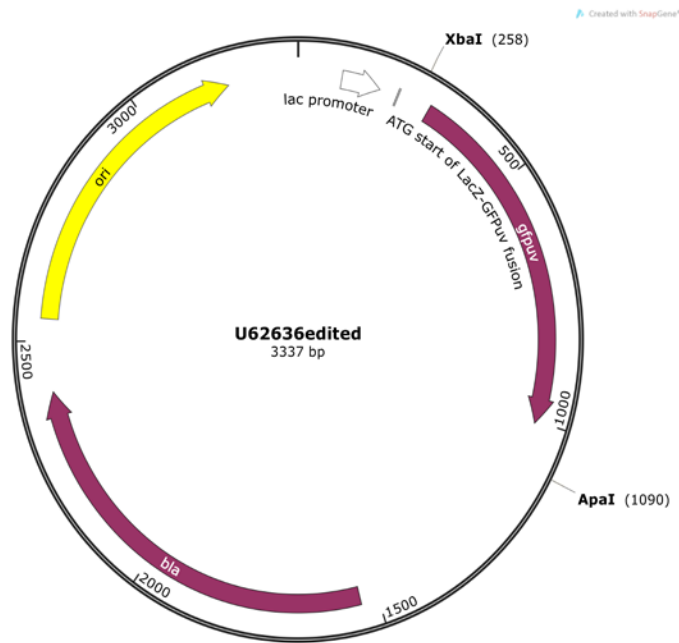


**Figure 4-2.** pBBR1mcs-3 plasmid carries many restriction enzyme sites and tetracycline gene.

#### 4.11 Green fluorescence protein plasmid (pGFPuv)

It is a Green Fluorescence Protein plasmid carrying *uv* gene (pGFPuv) with 3300 base pairs (GenBank Accession. U62636). In addition to *uv* gene, it also carries ampicillin resistance gene, *lac* promoter, and *lacZ* peptide (Clontech laboratories). Bacteria that acquire pGFPuv are resistant to ampicillin and produce a fluorescent color when exposed to uv light. As a result, researchers prefer this gene as a marker for their cloning experiments. This plasmid also has

restriction sites for many enzymes (Fig. 4-3). In this research, three restriction enzymes were applied as *SacII* (newly added) and *ApaI*, which were used to ligate the whole GFPuv gene (i.e. lac promoter is included) and *XbaI* which cuts after *lac* promoter if we want to replace GFPuv with a second (different) gene.

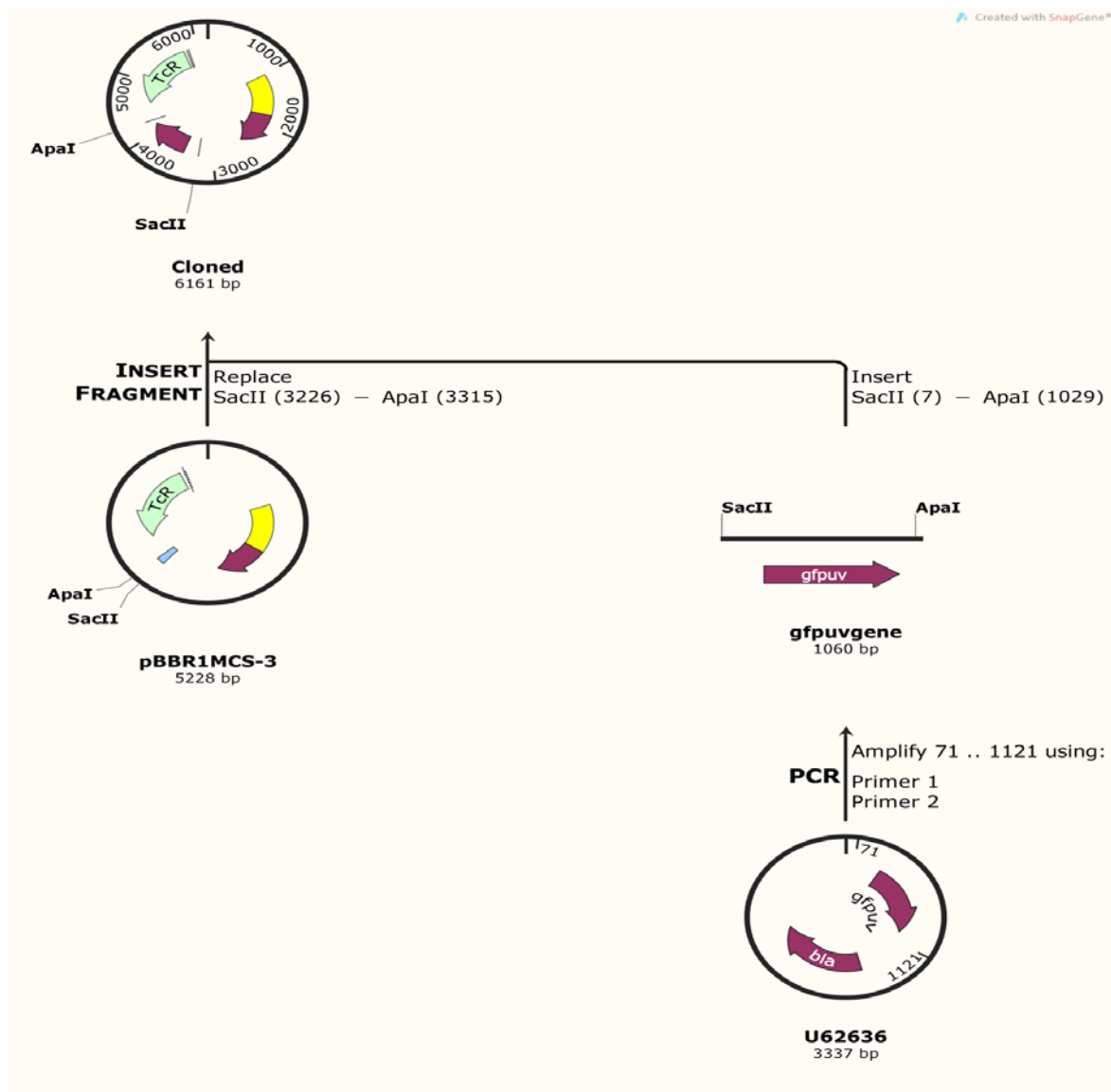


**Figure 4-3. pGFPuv carries *XpaI*, *ApaI*, *lac* promoter, and ampicillin**

#### 4.12 pAEM-1

The first step was to design PCR primers containing the beginning sequences of *uv* gene and new designed *SacII* restriction site (see above), and a successful PCR backward primer at the end of GFP gene that contains the *ApaI* sequence. The *Lac* promoter is present between 95 and 178 bp so the *SacII* site was built at 90 bp. *ApaI*, past the 3' end of the *uv* gene, is at 1090 bp. As mentioned before pBBR1mcs-3 has restriction sites to *SacII* and *ApaI*, therefore, the PCR product is complementary since both possess the same restriction sequence. Now the newly synthesized pAEM-1 carries the genes and several multiple cloning sites, namely *lac* operon,

*LacZ* peptide, GFPuv,  $Te^R$ , and sequences of *SacII*, *ApaI*, and *XbaI* (Fig. 4-4). *XbaI* site is located after *lac* promoter at 284 bp. We can replace the GFPuv gene with any other gene that contains *XbaI* and *ApaI*; at the same time, we retain the *lac* promoter. This strategy resulted in an isopropyl  $\beta$ -D-1-thiogalactopyranoside (IPTG) inducible shuttle plasmid for *P. fluorescens* and *E. coli*.



**Figure 4-4. Construction of a new designed pAEM-1.** The plasmid contains GFPuv gene, *lac* promoter, tetracycline resistance genes and restriction sites for *SacII*, *ApaI*, and *XbaI*.

#### 4.13 PCR technique

Amplification was carried out using a platinum PCR kit which contains nucleotides, enzyme, and buffer components. The primers were ordered from Integrated DNA Technologies (IDT) in a lyophilized form as followed: Forward primer was  $5' \text{GATCCGCGGTCCCGACTGGAA} 3'$ , G+C % = 66.6%, Tm = 63.8°C. Backward primer was  $5' \text{ACCGTCATCACCGAAACGCGC} 3'$ , G+C % = 61.9%, Tm = 62.9°C. The preparation of primers was done by adding 57  $\mu\text{L}$  and 54  $\mu\text{L}$  of TE to 26.9 nMol and 28.5 nMol of lyophilized forward (*SacII*) and backward (*ApaI*) primers, respectively, to create a master stock solution. One microliter from each stock solution was mixed with 99  $\mu\text{L}$  of deionized sterile distilled water and 1  $\mu\text{L}$  of each primer was transferred and mixed together in a tube contains 0.5  $\mu\text{L}$  of pGFPuv and 22.5  $\mu\text{L}$  of platinum super mix reagent (total = 25  $\mu\text{L}$ ). The tube was put in a PCR machine which was programed for 2 hours and 20 minutes to complete 29 cycles. Each cycle consists of 92°C, 57°C, and 72°C for denaturation, annealing, and elongation, respectively. Time was 40 seconds for each step. Four microliters of the PCR sample was run on agarose gel electrophoresis at 190 volt to isolate the PCR product that carries the newly designed 5' end (contains DNA sequences for *SacII* restriction enzyme). Isolation of the GFP gene was achieved by adding 20  $\mu\text{L}$  of flash gel recovery buffer to the recovery well after stopping DNA movement by turning off power. Note when we isolated uv gene, we repeated agarose gel electrophoresis to confirm our experiment. Then, the pure uv gene was cloned in pBBRmcs-1.

#### 4.14 Agarose gel electrophoresis

We have applied gel electrophoresis on all DNA types that used in our work. The parameters like amount of the samples, and the electricity voltage are the same. In addition, after we worked on restriction enzymes or PCR products experiments, we had confirmed the results with gel

electrophoresis. Precast gels were purchased from Lonza (Flash gel system). The samples were tested by mixing 4  $\mu\text{L}$  of the sample + 1  $\mu\text{L}$   $\text{H}_2\text{O}$  + 1  $\mu\text{L}$  dye (total = 6  $\mu\text{L}$ ) and pipetted into the well. Same amount of mixed ladder (DNA #50473. 4000 bp) was also added to the well. When the gel was put in electrical field (200 v/20 mins), the DNA of samples and ladder moved from negative to positive, leaving bands according to their molecular weight.

#### **4.15 Cloning of pAEM-1**

The *uv* gene was cloned into pBBR1mcs-3 as both have same restriction sites. First, 20  $\mu\text{L}$  of pBBR1mcs-3 was added to 3 different tubes containing *SacII*, + *ApaI*. Two and half microliter of 10 $\times$  of digestion buffer and 1 – 3 ml enzyme were added in each tube. The samples were incubated for 1 hour at 37°C. The samples were run on agarose gel electrophoresis to confirm restriction of pBBR1mcs-3, and the digested plasmid was recovered from the gel.

For ligation, first the restriction enzymes were denatured by incubation of the samples at 65°C for 10 minutes. After that, 5  $\mu\text{L}$  of PCR product, 1  $\mu\text{L}$  ligase enzyme, 1  $\mu\text{L}$  ligase buffer, and 4  $\mu\text{L}$   $\text{H}_2\text{O}$  were added to the tube containing pBBRmcs-1. Ligation was achieved after incubation of the sample overnight at 16°C. Agarose gel electrophoresis indicated two bands were not present, suggesting the ligation was successful. The sample was stored at -20°C for upcoming transformation in *E. coli* by heat shock method and in *P. fluorescens* by electroporation.

#### **4.16 Transformation of pAEM-1 to *E. coli***

Our *E.coli* strain naturally is sensitive to tetracycline and other antibiotics; at the same time, pAEM-1 carries tetracycline resistance gene marker. Subsequently, we confirmed our cloning and transformation success by culturing it on LB broth and agar-containing 10  $\mu\text{g}$  /ml

tetracycline (LB-TE). In addition we cultured *E. coli* before transformation on LB-TE agar as a control for sensitivity to tetracycline (no growth was reported after 2 days of incubation).

*E. coli* strain BL21 was obtained from New England Biolabs. The technique of transformation used on pAEM-1 to *E. coli* is called the heat shock method. A frozen *E. coli* (-80°C) was incubated in ice for 10 minutes. One microliter of DNA plasmid (pAEM-1) was added to cells and incubated in ice for 20 minutes. Immediately, the tube was put in water bath at 42°C for 10 seconds and returned to the ice for 5 minutes. Finally, 100 µL of the sample was added to 1 ml of Super Optimal Broth (S.O.C) and kept in the shaker for one hour at 37°C at 200 rpm. One hundred microliters of transformed *E. coli*-containing broth were spread over LB-TE agar and incubated for 24 hours at 37°C. On the next day, visible separated colonies had grown over the plate. *E. coli* had undergone plasmid uptake due to growth in the presence of tetracycline.

#### **4.17 Plasmid recovery**

To recover the plasmid, we used a Plasmid Mini Kit from Qiagen. The steps were carried out according to Qiagen Plasmid Purification Handbook. A separate colony was cultured in LB-TE broth for 18 hours at 26°C, and 24 hours at 37°C for *P. fluorescens* and *E. coli* respectively. One ml of cultured broth was transferred to 1.5 ml centrifuge tube (we used three tubes) and centrifuged at 14000 rpm for 3 minutes at 4°C. The supernatant was discarded and the cells were resuspended by adding 0.3 ml of P1 containing RNase (complete suspension achieved by vortex for 30 seconds). Same amount (0.3 ml) of P2 was added and mixed thoroughly by inverting the sealed tube four times (viscous appearance was observed) and incubating at room temperature for 15 minutes. A chilled buffer P3 was added (300 µl) and mixed by inverting six times (a fluffy white precipitate formed) and placed in ice for 5 minutes. The sample was mixed again and

centrifuged at 1400 rpm for 10 minutes. About 750 ml of clear supernatant containing plasmid DNA was collected by pipet and transferred to another sterile eppendorf tube. Before adding the supernatant-containing plasmid to Qiagen-tip 20, we equilibrated the column by adding 1 ml of buffer QBT and allowed it to empty by gravity flow. Then the supernatant was applied to Qiagen-tip 20 and allowed to enter the resin. The column was washed twice with buffer QC. After buffer QC completely passed through, the elution of plasmid was done by adding 0.8 ml of buffer QF and collected in a 1.5 ml size microcentrifuge tube. For precipitation and recovery of the plasmid, 0.56 ml of isopropanol was mixed with 0.8 ml of the eluted plasmid and centrifuged at 1400 rpm for 30 minutes. In this step, the plasmid was precipitated; therefore, we carefully discarded the supernatant. The plasmid then was washed with 1 ml of 70% ethanol and centrifuged at 14000 rpm for 10 minutes. The supernatant was removed and the tube was left in clean place for about 30 minutes to dry by air. The dried plasmid was dissolved in 70  $\mu$ L of TE buffer. Finally, 4  $\mu$ L of plasmid was transferred to a sterile 0.5 ml sized tube for agarose gel electrophoresis, while the remaining 65  $\mu$ L was frozen at  $-20^{\circ}\text{C}$ .

#### **4.18 Transformation of pAEM-1 to *P. fluorescens* by electroporation**

Electroporation is very effective technique to transform a bacteria with DNA (Drury, 1994).

When a short electric pulse applied to a mixture of bacteria and plasmid, small pores in bacterial cell membrane are formed through which plasmids may enter.

A few colonies of *P. fluorescens* were inoculated in five ml LB broth and incubated in the shaker for 17 hours at  $26^{\circ}\text{C}$ . This tube was used to inoculate 50 ml of the same media and reincubated in the shaker again. Every hour, the  $\text{O.D}_{600}$  was measured spectrophotometrically till it reached 0.5, which means the bacteria are in mid-exponential phase and are very active. The cells were

harvested by centrifuging 1.5 ml of the bacterial broth for 5 minutes at 10 rpm. The supernatant was carefully poured off and the pellets were washed three times by adding, each time, 750 ul of sterile ice-cold distilled water and centrifuge at the same rpm but for only one minute. Wash of pellets was repeated three times to eliminate all salts. Water was discarded and pellets were suspended by pipetting five times then chilled on ice. One microliter of pAEM-1 was added to the cells pellets chilled on ice again for 15 minutes. One hundred microliter of the mixture was put in cooled plastic cuvette containing electrodes and transferred to a cool Micro-Electroporation Chamber. Immediately, an electric pulse of 2400 volts/cm was applied. The cells were incubated on ice again for five minutes. Similar to heat shocking, 1 ml SOC broth (without tetracycline) was added to the mixture and incubated at 26°C for one hour. One hundred microliter was pipetted and spread on LB agar containing 10 µg/ml tetracycline and incubated at 26°C for 17 hours. Visible colonies were shown after 12 hours which were collected and tested to confirm the expression ability of pAEM-1.

#### **4.19 Design of His-6 tag containing FC**

FC was designed using computer software to cover the requirements of in vitro gene synthesis. Fragment C tetanus toxoid is located between the amino acids of 458 and 1315 of the whole tetanus toxin (<http://www.ncbi.nlm.nih.gov/nuccore/X04436.1>). When we started to add new restriction site sequences in both ends one for *XbaI* and the other for *ApaI*, we found *ApaI* has another site inside the gene which is a codon of the amino acid leucine; therefore, the third nucleotide adenine was substituted by thymine to preserve the same amino acid leucine. At the same time, the change prevented the action of *ApaI*. Six codons of histidine were added directly after the *XbaI* sequence at the beginning of the gene (Fig. 4-5). Unfortunately, *XbaI* did not digest for an unknown reason. Finally we determined the problem. The *E. coli* used by IDT to



synthesis our gene methylated the plasmid, rendering *XbaI* moot. To remedy this issue, we subcloned into dam *E. coli* to produce digestible material. Restriction by *XbaI* and *Apal* was repeated and two bands appeared; one for His6-FC of about 1500 bp and the other for the remaining plasmid circumventing the GATC issue (Fig. 4-6).

Sales Nbr: 11974268

Order Date: 06/30/201

Ref ID: 147696463

Gene Name: pUCIDT-AMP : His6FcCodonChange

Gene Size: 1169 bp

Plasmid Weight: 2,422,806.7 g/mole

### Sequence Detail

```

00001 TCGCGCGTTT CGGTGATGAC GGTGAAAACC TCTGACACAT GCAGCTCCCG GAGACGGTCA CAGCTTGTCT GTAAGCGGAT
00081 GCCGGGAGCA GACAAGCCCG TCAGGGCGCG TCAGCGGGTG TTGGCGGGTG TCGGGGCTGG CTTAACTATG CGGCATCAGA
00161 GCAGATTGTA CTGAGAGTGC ACCAAATGCG GTGTGAAATA CCGCACAGAT GCGTAAGGAG AAAATACCGC ATCAGGCGCC
00241 ATTCGCCATT CAGGCTGCGC AACTGTTGGG AAGGGCGATC GGTGCGGGCC TCATCGCTAT TACGCCAGCT GGCAGAAAGG
00321 GGATGTGCTG CAAGGCGATT AAGTTGGGTA ACGCCAGGGT TTTCCAGTTC ACGACGTTGT AAAACGACGG CCAGTGCAAC
00401 GCGATGACGA TGGATAGCGA TTCATCGATG AGCTGACCCG ATCGCCGCGG CCGGAGGGTT GCGTTTGAGA CGGGCGACAG
00481 ATGACTCTAG ATCACCATCA CCATCACCAT GATATCGAAT ACAATGATAT GTTCAATAAC TTCACCGTCT CCTTCTGGCT
00561 GCGGGTCCCG AAGGTGTGCG CGTCCCACCT GGAGCAATAT GGGACGAATG AGTACAGCAT CATCTCGTCC ATGAAGAAGC
00641 ACTCCTTGAG CATCGGGAGC GGGTGGAGCG TGTCGCTCAA AGGGAACAAAC CTCATCTGGA CCCTCAAGGA CAGCGCGGGG
00721 GAAGTCCGCC AGATCACCTT CCGCGATCTC CCGGACAAAT TCAATGCCTA TCTGGCGAAC AAGTGGGTGT TCATCAGCAT
00801 CACCANTGAT CGGCTCAGCT CCGCGAATCT CTATATCAAC GGGGTCTCTA TGGGCTCGGC GGAAATCACC GGCCTGGGGG
00881 CCATCCGCGA GGACAATAAT ATCACCCTGA AGCTCGACCG CTGCAACAAC AACAAACAAT ACCTCTCCAT CGATAAGTTC
00961 CGCATCTTCT GCAAGGCGCT GAATCCGAAG GAGATCGAAA AGCTCTATAC CTCGTATCTC AGCATCACGT TCCTGCGCGA
01041 TTTCTGGGGG AACCCCTGCG GGTATGACAC CGAGTACTAT CTGATCCCGG TCGCGTCTGC GTCGAAGGAC GTGCAACTCA
01121 AAAATATCAC GCACTACATG TACCTCACCA ATGCCCCGCT GTATACGAAT GGGAAAGTGA ACATCTATTA TCGGCGCCTC
01201 TATAACGGGC TCAAATTCAT CATCAAGCGG TATACGCCGA ACATGAGAT CGATTCCTTC GTGAAGTCCG GGGACTTCAT
01281 CAAACTGTAT GTGTCCTACA ATAACAACGA GCATATCGTG GGCTACCCCA AGGACGGGAA CGCCTTCAAC AATCTCGATC
01361 GGATCCTGGG CGTGGGCTAT AACGGCGCGG GCATCCCCCT GTACAAAAAG ATGGAGGCGG TCAAATCCCG GGATCTCAAG
01441 ACGTATTCGG TGCAGCTCAA ACTCTACGAC GATAAGAATG CCTCCCTCGG CCTCGTGGCC ACGCATAACG GCCAGATCGG
01521 GAATGATCCC AATCGGGACA TCTGTATCGC GAGCAATTGG TATTTCAACC ATCTCAAGGA CAAGATCCCTG GGTAGCGGAT
01601 GGTATTTCTG CCCCACGGAT GAGGGCTGGA CCAACGATTA AGGGCCCTTT CATCAGTTCT GGACCAGCGA GCTGTGCTGC
01681 GACTCGTGGC GTAATCATGG TCATAGCTGT TTCTGTGTGG AAATGTGTTAT CCGCTCACAA TTCCACACAA CATACGAGCC
01761 GCAAGCATAA ACTGTAAAGC CCGCGCTGCG TAACTGCTGA GCTAACTTAC ATTAATTTGG TTGCGCTCAC TGCCTCTTTT

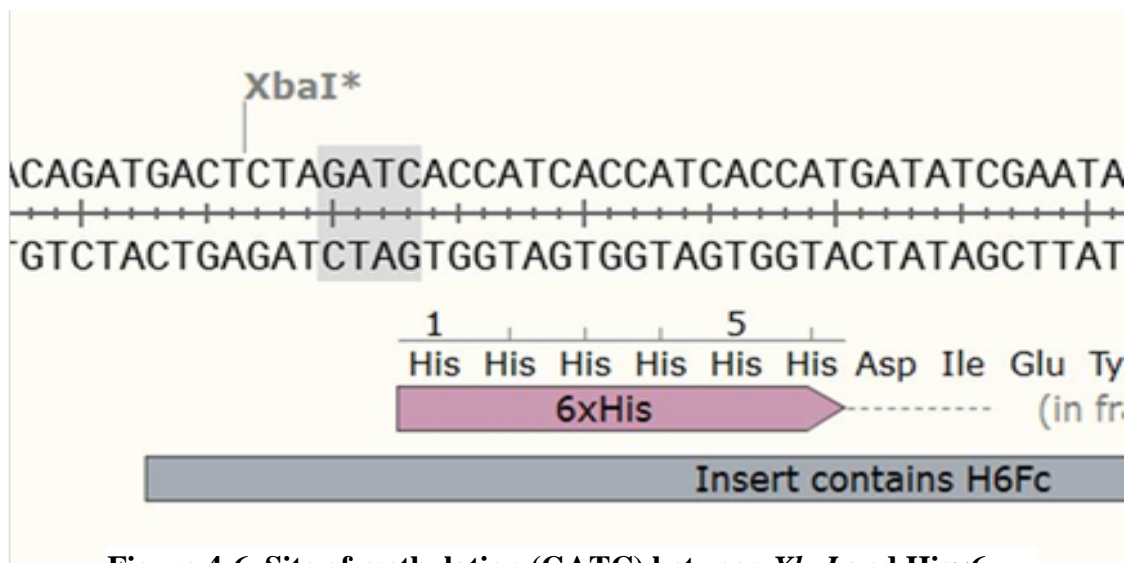
```

Figure 4-5. Whole sequence of FC contains *XbaI* restriction site and His×6 tag sequence.

```

02001 ATACGGTTAT CCACAGAATC AGGGGATAAC GCAGGAAAGA ACATGTGAGC AAAAGGCCAG CAAAAGGCCA GGAACCGTAA
02081 AAAGGCCGCG TTGCTGGCGT TTTTCCATAG GCTCCGCCCC CCTGACGAGC ATCACAAAAA TCGACGCTCA AGTCAGAGGT
02161 GCGCAAAACC GACAGGACTA TAAAGTATCC AGGCGTGTTC CCCTGGAAGC TCCTCGTGTG GCTCTCTGTG TCCGACCCTG
02241 TCGCTTACCG GATACCTGTC CGCCTTTCTC CCTTCGGGAA GCGTGGCGCT TTCTCATAGC TCACGCTGTA GGTATCTCAG
02321 TTCGTTGTAG GTCGTTGCGT CCAAGCTGGG CTGTGTGTCAC GAACCCCGCG TTCAGCCCGA CCGCTGCGCC TTATCCGGTA
02401 ACTATCGTCT TGAGTCCAAC CCGGTAAGAC ACGACTTATC GCCACTGGCA GCAGCCACTG GTAACAGGAT TAGCAGAGCG
02481 AAGTATGTAG GCGGTGCTAC AGAGTTCCTG AAGTGGTGGC CTAACTACGG CTACACTAGA AGAACAGTAT TTGGTATCTG
02561 CGCTCTGCTG AAGCCAGTTA CCTTCGGAAA AAGAGTTGGT AGCTCTTGAT CCGGCAAAAC AACCCCGCTG GGTAGCGGTG
02641 GTTTTTTTGT TTCAAGCAGC CAGATTACGC GCAGAAAAAA AGGATCTCAA GAAGATCCTT TGATCTTTTC TACGGGGTCT
02721 GACGCTCAGT GGAACGAAAA CTCACGTTAA GGGATTTTGG TCATGAGATT ATCAAAAAGG ATCTTCACCT AGATCCTTTT
02801 AAATGAAAAA TGAAGTTTTA AATCAATCTA AAGTATATAT GAGTAAACCT GGTCTGACAG TTACCAATGC TTAATCAGTG
02881 AGGCACCTAT CTCAGCGATC TGTCTATTTT GTTCATCCAT AGTTGCCTGA CTCCCGCTCG TGTAGATAAC TACGATACGG
02961 GAGGCGTTAC CATCTGGCCC CAGTGTGTCG ATGATACCGC GAGACCCACG CTCACCGGCT CCAGATTTAT CAGCAATAAA
03041 CCAGCCAGCC GGAAGGGCGG AGCGCAGAAG TGGTCTGCA ACTTTATCCG CCTCCATCCA GTCTATTAAT TGTGCGCGGG
03121 AAGCTAGAGT AAGTAGTTCG CCAAGTTCG CCAAGTTCG GATGCAATAC CGTTGTTGCC ATTGCTACAG GCATCGTGGT TTGATCCTCG
03201 TCGTTTGGTA TGGCTTCATT CAGCTCCGGT TCCCAACGAT CAAGGCGAGT TACATGATCC CCCATGTTGT GCAAAAAAGC
03281 GGTTAGCTCC TTCGGTCTCT CGATCGTTGT CAGAAGTAAG TTGGCCCGAG TGTATCACT CATGTTATG GCACGACTCG
03361 ATAATTCTCT TACTGTCTAT CCATCCGTAA GATGCTTTTC TGTACTGAT GAGTACTCAA CCAAGTCATT CTGAGAATAG
03441 TGTATGCGGC GACCGAGTTG CTCTTGCCCG GCGTCAATAC GGGATAATAC CCGCCACAT AGCAGAACTT TAAAAGTGTCT
03521 CATCATTGGA AAACGTTCTT CGGGGCGAAA ACTCTCAAGG ATCTTACCAG TGTGAGATC CAGTTCGATG TAACCCACTC
03601 GTGCACCCAA CTGATCTTCA GCATCTTTTA CTTTACCAGC CGTTTCTGGG TGAGCAAAAA CAGGAAGGCA AAATGCGCGA
03681 AAAAAGGAAA TAAGGGCGAC ACGGAAATGT TGAATACTCA TACTCTACCT TTTTCAATAT TATTGAGCA TTTATCAGGG
03761 TTAATGTCTC ATGAGCGGAT CATATTTTGA ATGTTATTAG AAAATAAAC AAATAGGGGT TCCGCGCACA TTTCCCGGAA
03841 AAGTCCACC TGACGCTTAA GAAACCATA TTATCATGAC ATTAACCTAT AAAAATAGGC GTATCACGAG GCCCTTCTGT

```



**Figure 4-6. Site of methylation (GATC) between *XbaI* and His $\times$ 6**

#### 4.20 Construction of pAEM-2-His6-FC

Plasmid Ahmed Elmasheiti-2-His6-fragment C (pAEM-2-His6-FC) is a modified version of pGFPuv. As mentioned above, the multiple cloning site of pGFPuv contains sequences for *XbaI* and *Apal* in the beginning and in the end of the uv gene. The uv gene was cut out and replaced by His6-FC. All the techniques were carried out as similarly described. When the plasmid was transformed to and His6-FC protein expressed protein from *E. coli* and *P. fluorescens*, the His6-FC protein was detected by a simple and fast tag staining technique.

#### 4.21 Detection of His6 Tag-FC protein

Thermo Scientific Company developed a new reagent that is able to detect any protein tagged with six histidines. The kit (Pierce 6 $\times$ His Protein Tag Stain Reagent Set) is composed of only two reagents. After electrophoresis, gels were washed with 100 ml of ultrapure water three times by gently agitation for 20 minutes. The gel was transferred to a container containing 50 ml of 6 $\times$ His Protein Tag Stain (reagent no. 1) and agitated for 5 minutes. The gel was washed again two times by 100 ml of ultrapure water for 15 minutes, followed by immersion in 6 $\times$ His Protein

Tag Developer (reagent no. 2) for 15 minutes. Finally, the gel was wash two times with same amount of water for 15 minutes. The gel then placed under CCD camera and only protein bands tagged with histidine were shown. To calculate the molecular weight of the target protein comparing to the standard bands size, the gel was stained again with traditional Coomassie blue.

#### **4.22 Transformation of pGFPuv to *E. coli* and *P. fluorescens***

The procedure was carried out by heat shock method same as that used for transformation of pAEM-1 and to *P. fluorescens* by electroporation. *Pseudomonas fluorescens* has natural resistance to ampicillin, therefore to establish pGFPuv (which carries ampicillin resistance gene), the concentration of AMP in the agar and broth was elevated from 100 µg/ml to 150 µg/ml. Detection of plasmid transformed in *E. coli* was shown by presence of colonies on ampicillin-containing LB agar. In *P. fluorescens*, uv illumination of colonies on broth indicate plasmid uptake. In addition, plasmid was recovered from both bacteria, and showed as 3000 bp band on an electrophoresis gel.

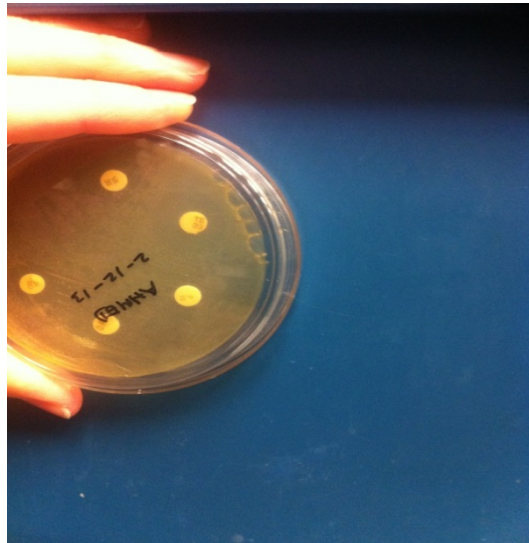
#### **4.23 Restriction of GFP gene from pGFPuv using *XbaI* and *ApaI* restriction enzymes**

The pGFPuv that extracted from *E. coli* was examined by restriction using *XbaI* and *ApaI*, which cut at 258 bp and 1090; respectively. Two microliters of *XbaI* and *ApaI*; in addition to 2 µL of smart cut buffer were added to 19 µL of pGFPuv, bringing the total volume to 25 µL. The mixture was incubated at 37°C for one hour. Gel electrophoresis was run. Two bands clearly appeared on agarose gel. The small one for GFP gene, whereas the large one for the remaining plasmid. Large band (pGFPuv without GFP gene) was collected using 20 µL of DNA recovery buffer for the cloning of FC.

## 5. Results and Discussion

### 5.1 Selection of tetracycline marker

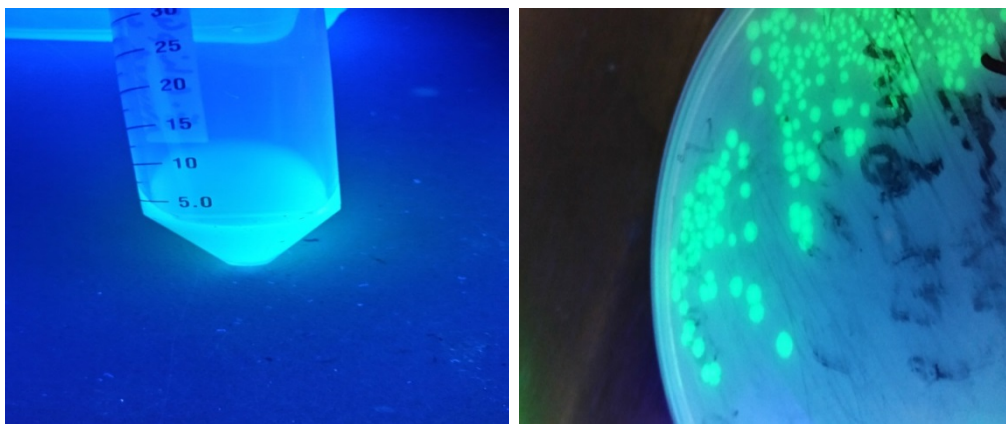
*P. fluorescens* is abundant in nature as microbial flora of soil water and plants. Due to competition within the microbiota, *P. fluorescens* produces inhibitors and antibacterial substances that permit survival in its niche. Depending on this fact, the strain was examined for antibiotic sensitivity to determine which one is effective against the tested strain for future cloning. After 17 hrs / 26°C of rehydrated lyophilized powder of *P. fluorescens* on LB agar, visible colonies were grown. Single colonies were isolated and cultured on the same agar and different antibiotics were put on the surface of the agar and incubated overnight at 26°C. Inhibition growth zones were shown around tetracycline and kanamycin disks, whereas, the bacteria exhibited some growth around ampicillin (Fig. 5-4). An intermediate inhibition zone around gentamycin had been observed. From previous reports, *P. fluorescens* and other *Pseudomonas* strains naturally carry resistance genes on their chromosomes mainly against ampicillin and are highly sensitive to tetracycline and kanamycin (Naghmouchi et al. 2012; Odjadjare et al. 2012; Sarniguet et al. 1995). For this reason, the plasmid pBBR1mcs-3 that carries tetracycline resistance gene was chosen and redesigned as shuttle vector to clone pGFPuv and genetically engineered FC tetanus toxoid genes.



**Figure 5-1. Kirby-Bauer disk diffusion susceptibility test appears resistance of *P. fluorescens* to tetracycline.**

### **5.2 Confirming the transform of *P. fluorescens* with pGFPuv**

*P. fluorescens* has natural resistance to ampicillin, therefore to established pGFPuv (which also carries the resistance gene), the concentration of antibiotic in the agar and broth was increased from 100 µg/ml to 150 µg/ml. Detection of plasmid transformed in *E. coli* was proven by grown colonies on AMP containing-LB agar; whereas, confirmed in *P. fluorescens* by fluoresce illumination of *P. fluorescens* colonies on agar and in broth when exposed to UV light (Fig. 5-5). In addition, plasmid was recovered from both bacteria and showed at 3000 bp.



**Figure 5-2. Illumination of pGFP-containing *P. fluorescens* in LB broth (left) and a LB agar (right) under ultraviolet light.**

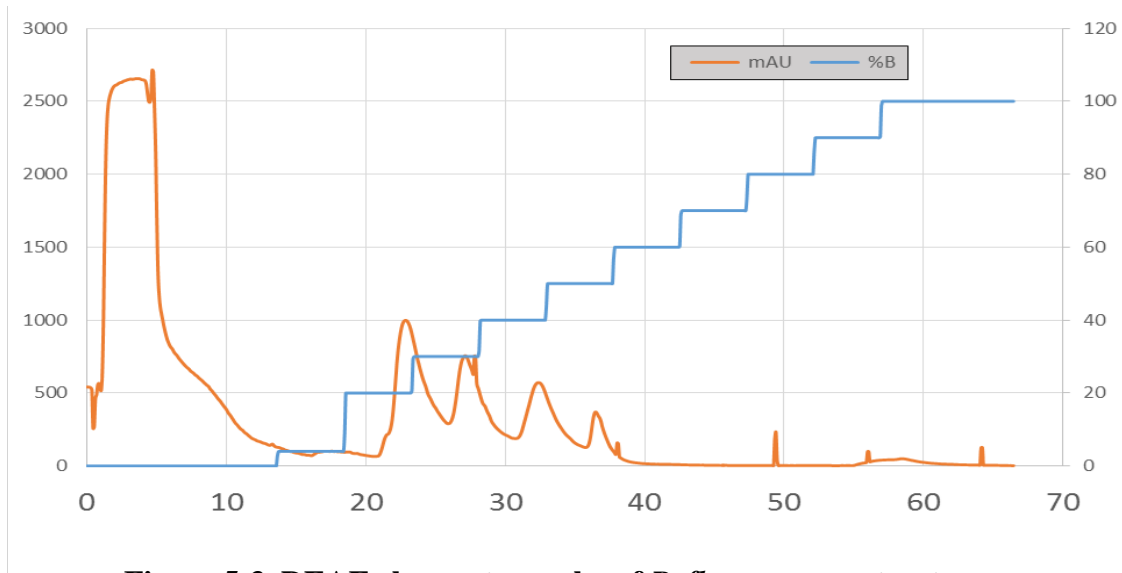
### 5.3 Cultivation of *P. fluorescens* by batch fermenter

As mentioned before, *P. fluorescens* is prototrophic which does not require special nutrients or environment to grow. Before we started cloning experiments, the strain was cultivated in a bioreactor to determine its productive ability. Only oxygen was supplied during batch, i.e. no glucose added or NaOH to adjust the pH. When finished, the dry weight was measured and the biomass was 60 g/0.5 L. However, a biomass of greater than 100 g/L<sup>-1</sup> was obtained by other workers (Fersht, 2008) . Our lower biomass may be attributed to the total volume of the LB media. In this research, we used only half liter of LB broth, whereas, the previous report had used one liter.

### 5.4 Total chromosomal proteins of *P. fluorescens* that bind DEAE

The subproteome associated with ion exchange chromatography of the wild type strain was identified prior to transformation. The pellets, which were collected from batch fermenter, were sonicated to lyse the cells and release protein. Ion exchange was carried out by FPLC. Figure 5-1 presents the chromatography profile of *P. fluorescens* extract as it elutes from a DEAE column. Similar to most profiles, it begins with a large peak of loosely bound protein that emerges quite early, in fact before the gradient begins. Subsequent steps in NaCl concentration force additional peaks to elute, while the majority of proteins emerging before 60% B or 600 mM NaCl. The highest peaks of adsorbed proteins were showed in samples numbers seven, eight, nine, and ten. Parallel results were recorded when the total protein was measured by the BioRad Protein Assay (Table 5-1). The samples were also run on SDS-PAGE (Fig. 5-2). Different bands of proteins were presented on the gel of the three samples at a concentration between 200 mM NaCl and 400 mM NaCl of buffer B. Four hundred microliters of desalted protein of each sample were tested

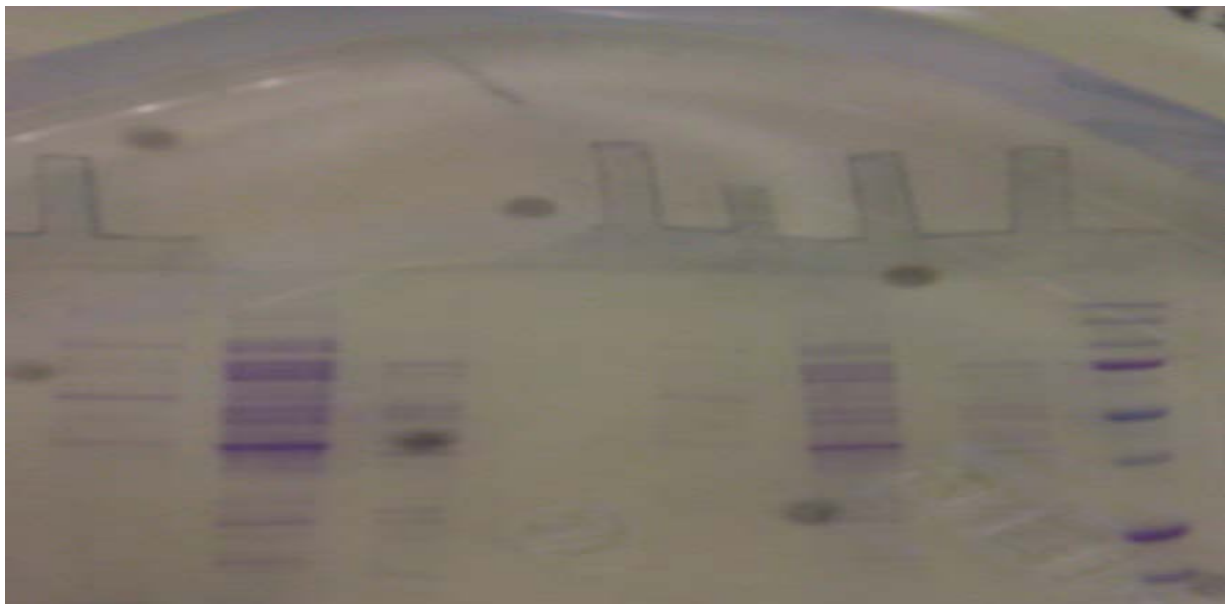
by mass spectrophotometer to identify the name and function of the proteins (Table 5-2). The first fifteen proteins were determined using Scaffold which estimated nine proteins as essential and six as non-essential proteins. Within the table, the concentration of each protein is given, calculated based on the spectral method of counting (Table 5-3).



**Figure 5-3. DEAE chromatography of *P. fluorescens* extract**

**Table 5-1. Protein concentrations measured by spectrophotometry.**

Sample no.	Conc. (mg/ml)	Buffer B Conc.
3	1.0394	100
4	0.06130	100
5	--	100
6		100
7	0.6588	200
8	0.2813	300
9	0.1808	400
10	0.1365	500
11	--	600
12	--	700
13	--	800
14	--	900
15	0.2737	1000



**Figure 5-4. Different bands of protein extracted from samples 7, 8, 9, and 10 on SDS-PAGE extracted from *P. fluorescens*.**



#	Visible?	Starred?	MS/MS View: Identified Proteins (273) Including 2 Decoys	Accession Number	Molecular Weight	Protein Grouping Ambiguity	Beit1e_080315_01.raw (F018827...	Beit1e_080315_02.raw (F018828...	Beit1e_080315_03.raw (F018829...	Beit1e_080315_04.raw (F018830...	Beit1e_080315_05.raw (F018831...	Beit1e_080315_06.raw (F018832...	Beit1e_080315_07.raw (F018833...	Beit1e_080315_08.raw (F018834...	Beit1e_080315_09.raw (F018835...	Beit1e_080315_10.raw (F018836...	Beit1e_080315_11.raw (F018837...
1	<input checked="" type="checkbox"/>	☆	1-(5-phosphoribosyl)-5-[(5-phosphoribosylamino)methylidene]...	HIS4_PSEFS	26 kDa	2	1										
2	<input checked="" type="checkbox"/>	☆	10 kDa chaperonin O5=Pseudomonas fluorescens (strain SBW...	C3K1A1_PS...	10 kDa	3	1						7				
3	<input checked="" type="checkbox"/>	☆	2,3-bisphosphoglycerate-independent phosphoglycerate mut...	C3K6V9_PS...	55 kDa	2	2										1
4	<input checked="" type="checkbox"/>	☆	2-isopropylmalate synthase O5=Pseudomonas fluorescens (st...	LEU1_PSEFS	62 kDa	2	2										
5	<input checked="" type="checkbox"/>	☆	3-oxoacyl-[acyl-carrier protein] reductase O5=Pseudomonas...	C3K0N4_PS...	26 kDa	1											
6	<input checked="" type="checkbox"/>	☆	3-oxoacyl-[acyl-carrier-protein] synthase I O5=Pseudomonas...	C3K6P2_PS...	43 kDa	3	3										
7	<input checked="" type="checkbox"/>	☆	30S ribosomal protein S1 O5=Pseudomonas fluorescens (strai...	C3K6K0_PS...	62 kDa	2	6	17	2								3
8	<input checked="" type="checkbox"/>	☆	30S ribosomal protein S10 O5=Pseudomonas fluorescens (stra...	RS10_PSEFS	12 kDa	2	2	6	1								
9	<input checked="" type="checkbox"/>	☆	30S ribosomal protein S12 O5=Pseudomonas fluorescens (stra...	RS12_PSEFS	14 kDa			2									
10	<input checked="" type="checkbox"/>	☆	30S ribosomal protein S13 O5=Pseudomonas fluorescens (stra...	RS13_PSEFS	13 kDa			1									
11	<input checked="" type="checkbox"/>	☆	30S ribosomal protein S14 O5=Pseudomonas fluorescens (stra...	C3K2W3_P...	11 kDa			2									
12	<input checked="" type="checkbox"/>	☆	30S ribosomal protein S18 O5=Pseudomonas fluorescens (stra...	RS18_PSEFS	9 kDa		1	1							3	4	
13	<input checked="" type="checkbox"/>	☆	30S ribosomal protein S2 O5=Pseudomonas fluorescens (strai...	RS2_PSEFS	27 kDa	3	3										1
14	<input checked="" type="checkbox"/>	☆	30S ribosomal protein S4 O5=Pseudomonas fluorescens (strai...	RS4_PSEFS	23 kDa		1										
15	<input checked="" type="checkbox"/>	☆	30S ribosomal protein S5 O5=Pseudomonas fluorescens (strai...	RS5_PSEFS	18 kDa	1	2										

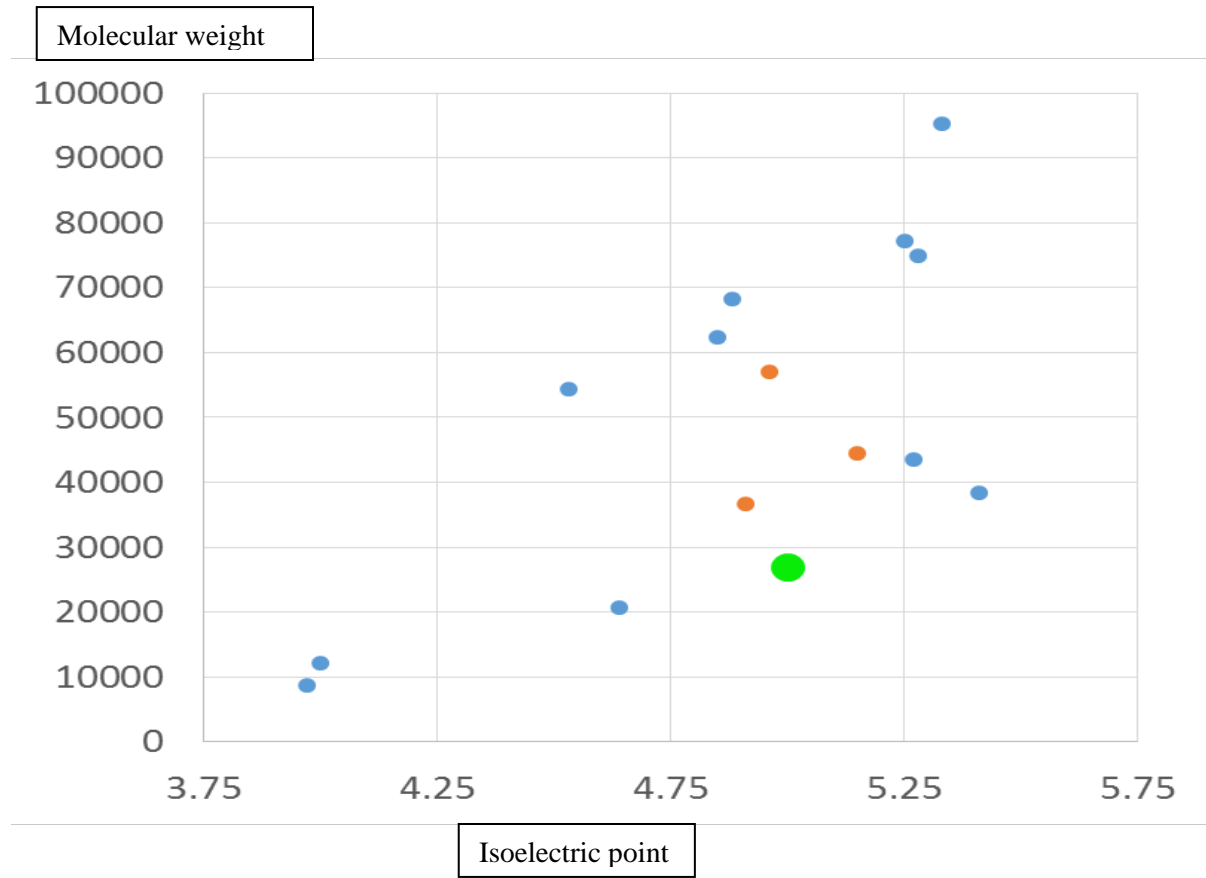
Table 5-2. Scaffold output. Numbers in green are hit count, as determined by mass spectroscopy.

**Table 5-3. Function entry from <http://www.uniprot.org/>. E= Essential and N= Nonessential.**

Protein	Function	Found in peak	% in single peak	% in all peaks	E/N	PI	MW
Elongation factor G	Catalyzes the GTP-dependent ribosomal translocation step during translation elongation.	1,4	11,34	45	E	5.25	77
Chaperone protein ClpB	Part of a stress-induced multi-chaperone system, it is involved in the recovery of the cell from heat-induced damage, in cooperation with DnaK, DnaJ and GrpE.	1,3,6	7,8,6	68	N	5.33	95
60 kDa chaperonin	Prevents misfolding and promotes the refolding and proper assembly of unfolded polypeptides generated under stress conditions.	2,4	7,8	34	N	4.96	57
Elongation factor Tu	Promotes the GTP-dependent binding of aminoacyl-tRNA to the A-site of ribosomes during protein biosynthesis.	2	12	66	E	5.27	43
Chaperone protein DnaK	Acts as a chaperone	4	5	23	N	4.88	68
Transcription termination/antitermination protein NusA	Participates in both transcription termination and antitermination.	2,4	6,12	100	E	4.53	54
Protein GrpE	Participates actively in the response to hyperosmotic and heat shock by preventing the aggregation of stress-denatured proteins, in association with DnaK and GrpE. It is the nucleotide exchange factor for DnaK and may function as a thermosensor.	2,4	7,9	66	E	4.64	21
Ferredoxin I	electron carrier activity	3	4	13	E	4.07	12
30S ribosomal protein S1	Binds mRNA; thus facilitating recognition of the initiation point. It is needed to translate mRNA with a short Shine-Dalgarno (SD) purine-rich sequence.	4	17	20	E	4.85	62
Polyribonucleotide nucleotidyltransferase	Involved in mRNA degradation. Catalyzes the phosphorolysis of single-stranded polyribonucleotides processively in the 3'- to 5'-direction.	2	4	100	N	5.28	75
50S ribosomal protein L18	One of the proteins that binds and probably mediates the attachment of the 5S RNA into the large ribosomal subunit, where it forms part of the central protuberance.	4	7	78	E	10.19	12
DNA-directed RNA polymerase subunit alpha	DNA-dependent RNA polymerase catalyzes the transcription of DNA into RNA using the four ribonucleoside triphosphates as substrates.	1,4	6,8	66	E	4.91	36
Fructose-bisphosphate aldolase	fructose-bisphosphate aldolase activity	2	4	85	N	5.41	38
Acyl carrier protein	Carrier of the growing fatty acid chain in fatty acid biosynthesis.	2	3	83	E	3.97	86
Aspartate kinase	Involved in the biosynthesis of L-aspartate-beta-semialdehyde which is a central intermediate in the biosynthesis of different amino acids	1,2,3	4,4,4	75	N	5.46	55

### 5.5 Elution with respect to GFPuv

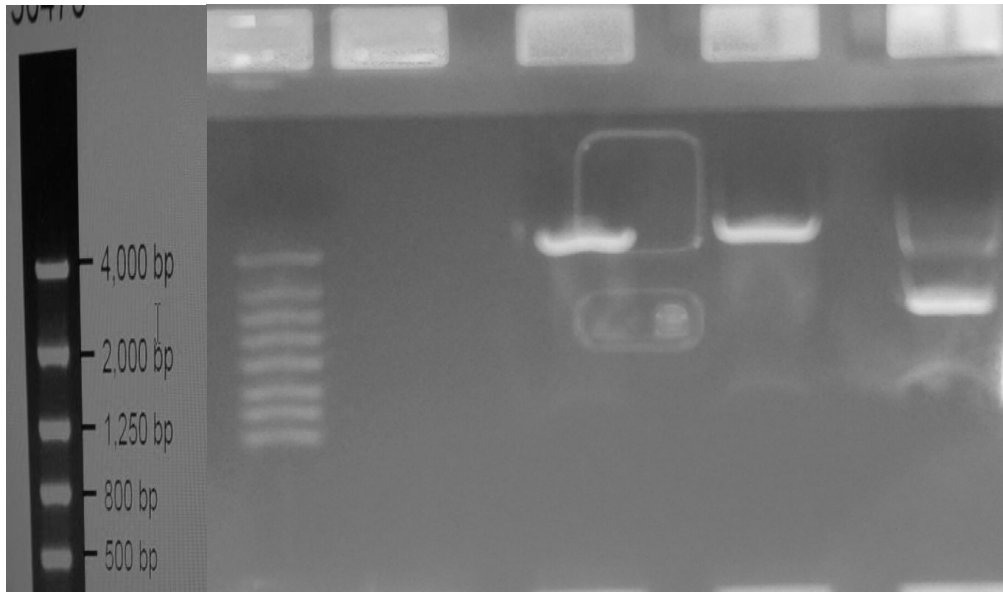
Should *P. fluorescens* be transformed with a plasmid that expresses GFPuv (pAEM-1), the chromatographic behavior of this recombinant product may be compared to the most abundant host cell proteins. Figure 5-3 is a plot of molecular weight and isoelectric point of the host cell proteins of *P. fluorescens* when fractionated by DEAE, with the large green dot denoting the MW and pI of GFPuv. If a vertical line is drawn through the dot, one encounters at least one HCP that would be difficult to isolate from a GFPuv containing fraction for its pI is relatively close to that of the model target protein. In fact, a similar argument could be made with respect to a second protein in terms of MW fractionation should a horizontal line be drawn. Data of this nature points to, in the case of GFPuv being produced by *P. fluorescens*, two classifications of proteins should be examined for deletion – those which have similar MW and pI properties to the target protein, and those which have strong DEAE retention. The first category would be difficult to remove as their properties are similar, and the second category wastes column capacity. Interestingly and with less fortune is the fact that of the proteins identified, most are considered essential based on literature information.



**Figure 5-5. Comparison of *P. fluorescens* extract properties to that of GFPuv.**

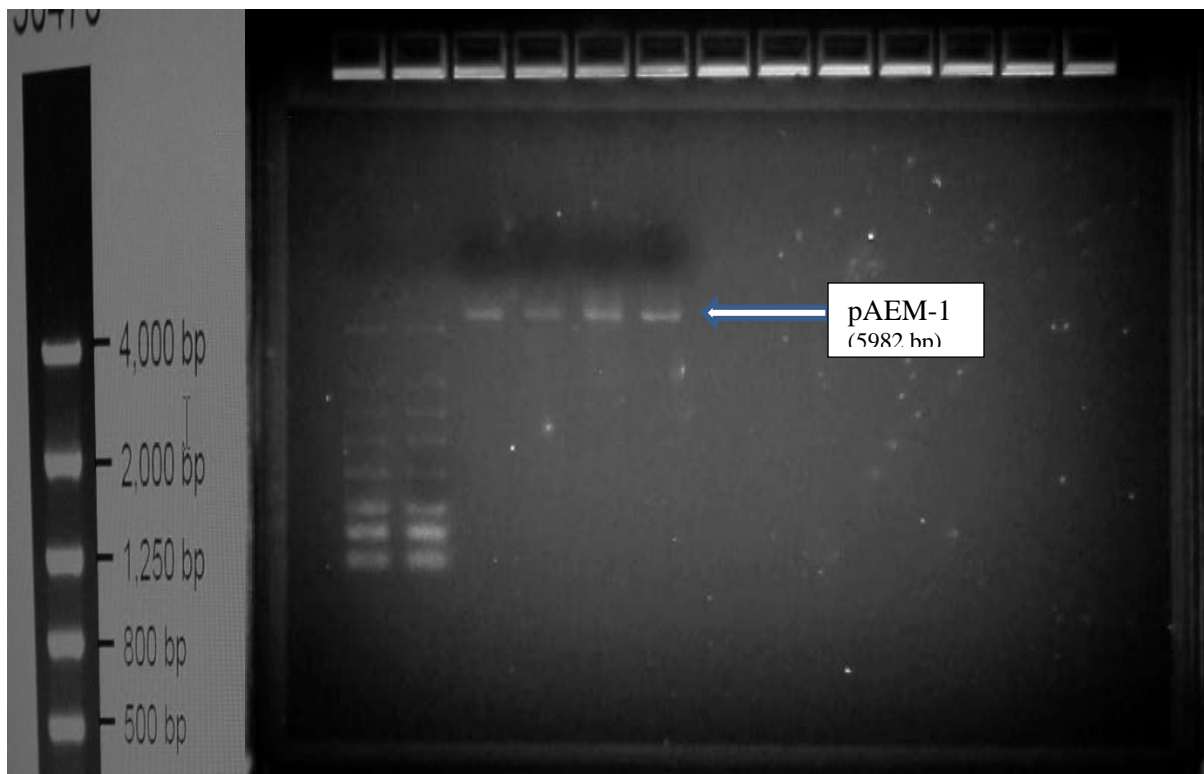
## 5.6 Construction of pAEM-1 containing green fluorescent protein gene

The new designed plasmid is a combination of two plasmids pBBR1mcs-3 and pGFPuv. The first one contains tetracycline resistance gene as marker and multiple cloning sites for many restriction enzymes. As far as we know, it is the first research that successfully transformed an expression vector pBBR1mcs-3 for *P. fluorescens*. The parent plasmid lacks functional *lac operon*; therefore, it is unable to be induced by lactose or IPTG. pGFPuv is widely used in research laboratories because it is a source of the GFPuv gene, in addition to being an expression vector. pGFPuv has a functional *lac operon* that when induced expresses the fluorescens protein. In our research we took the entire *lac operon* expresses GFP and added it to pBBR1mcs-3. The process started with PCR amplification, resulting in two bands visualized by electrophoresis. One was the expected size of the *lac operon* containing GFPuv gene (Fig. 5-6). The isolation of this band was achieved by adding 20  $\mu$ L of plasmid recovery reagent. The small band was collected and rerun on the gel to ensure recovery.



**Figure 5-6. Two separated bands.** Lane three shows the whole pGFPuv and the lane 5 shows only *lac operon* containing GFPuv gene.

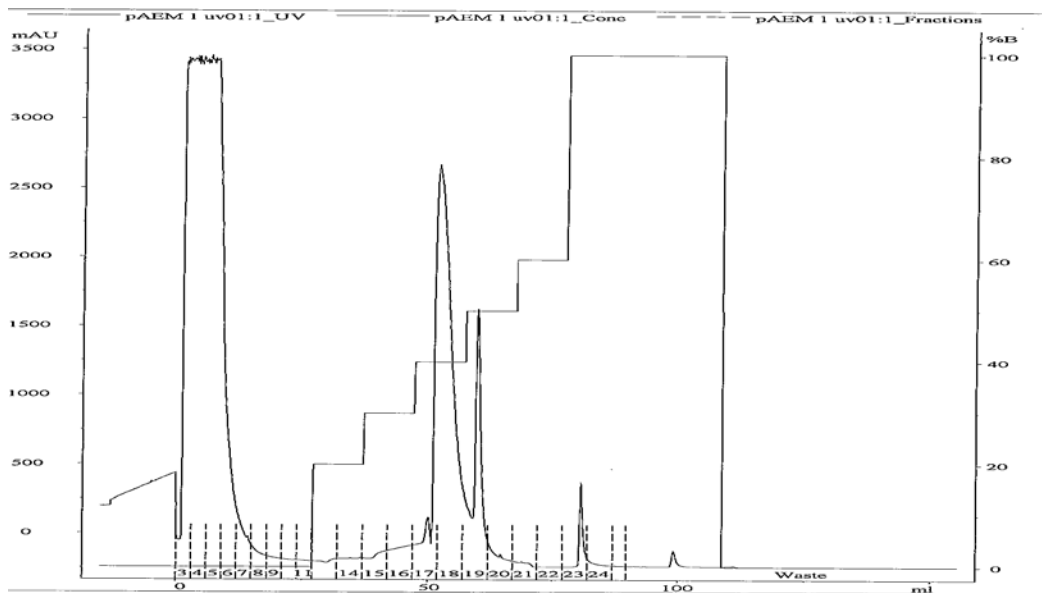
In the next step, pBBR1mcs-3 was cut with *ApaI* and *SacII*; however, the large band was collected, instead, from the agarose gel. Ligation of two bands similarly digested was successfully achieved after overnight incubation at 16°C when we showed only one band of our new designed plasmid (pAEM-1) on the gel (Fig. 5-7). The final confirmation of our experiment was apparent when both *E. coli* and *P. fluorescens* grew in tetracycline-containing LB broth and agar and showed bright green color when exposed to UV light.



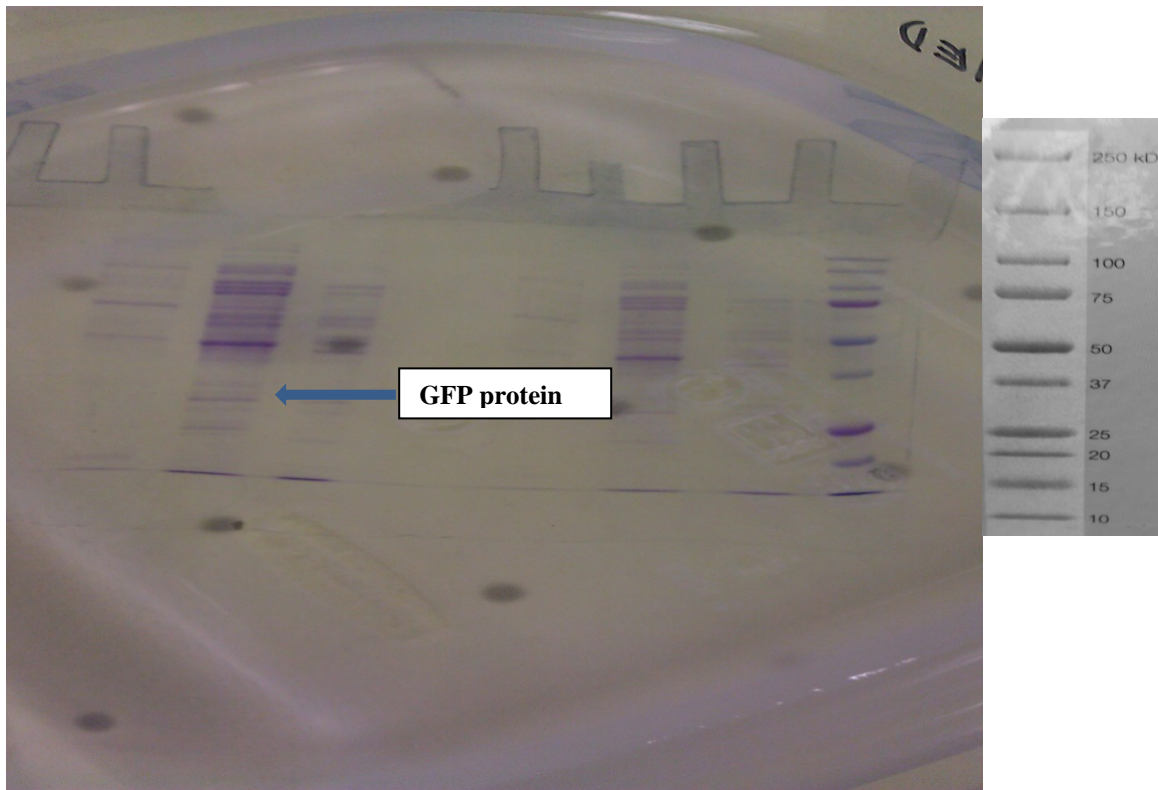
**Figure 5-7. Agarose gel electrophoresis appears DNA bands of pAEM-1.**

## 5.7 Purification of GFP expressed by *P. fluorescens*

The same techniques and steps that used to identify and purify *P. fluorescens* proteins were carried out on *P. fluorescens* containing pAEM-1. Line graph result from FPLC appeared high peaks in samples number 17, 18, and 19 (Fig. 5-8) and a green fluorescens color was emitted when those samples were exposed to UV light. The protein samples also run on SDS-PAGE where different bands were reported (Fig. 5-9). The molecular weight of Green fluorescens protein (GFP) alone is 26.9 kDa (238 amino acids) (Prendergast & Mann, 1978). In SDS-PAGE, the GFP band showed bigger than its normal size comparing with of the protein standards (catalog# 161-0374). The reason in deference between its original GFP molecular weight (26.9 kDa) and our result is because our GFP also contains *LacZ* peptide that together bring the total molecular weight of about 29.6 kDa.



**Figure 5-8. DEAE chromatography of proteins extracted from *P. fluorescens*: pAEM-1**

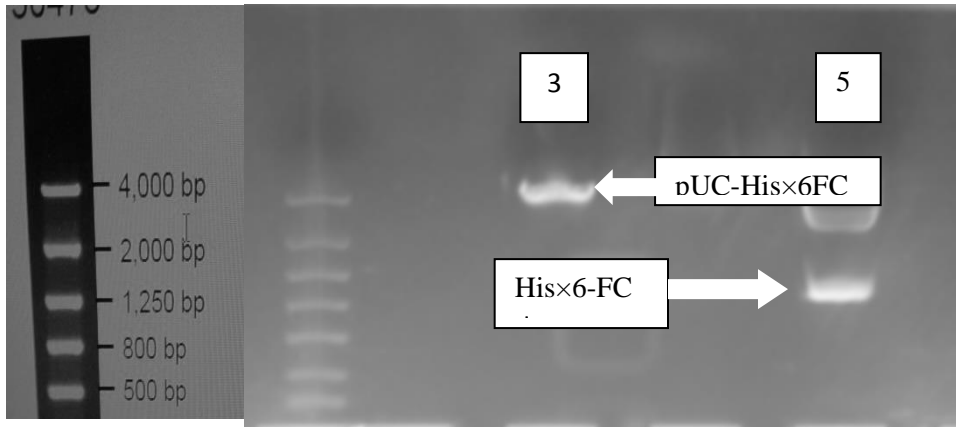


**Figure 5-9. Detection of GFP (about 27 KDa) protein by SDS-PAGE**

### **5.8 Restriction of His $\times$ 6-FC by *XbaI* and *ApaI* from dam *E. coli***

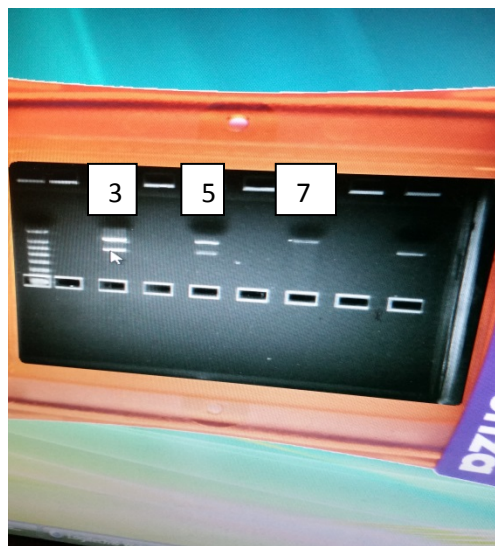
A His $\times$ 6 FC gene was ordered from IDT DNA and came as a clone within a pUC vector. Many times we tried to cut directly but the restriction site of *XbaI* did not respond. Another attempt was to subclone first to the most common laboratory used *E. coli* (strain BL21) recover plasmid and recut with *XbaI* but we got the same results. Finally, after a better examination of the DNA sequence, it was determined that methylation would stop *XbaI* from cutting the DNA. For that reason, we ordered special genetic engineered *E. coli* called dam *E. coli* where the genes that are responsible for methylation are deleted. Both enzymes worked perfectly and two bands were shown on agarose gel when digested (Fig. 5-10).





**Figure 5-10.** lane three appears whole pUC-His×6FC and lane five appears only His×6-FC after treated with *ApaI* and *XbaI*.

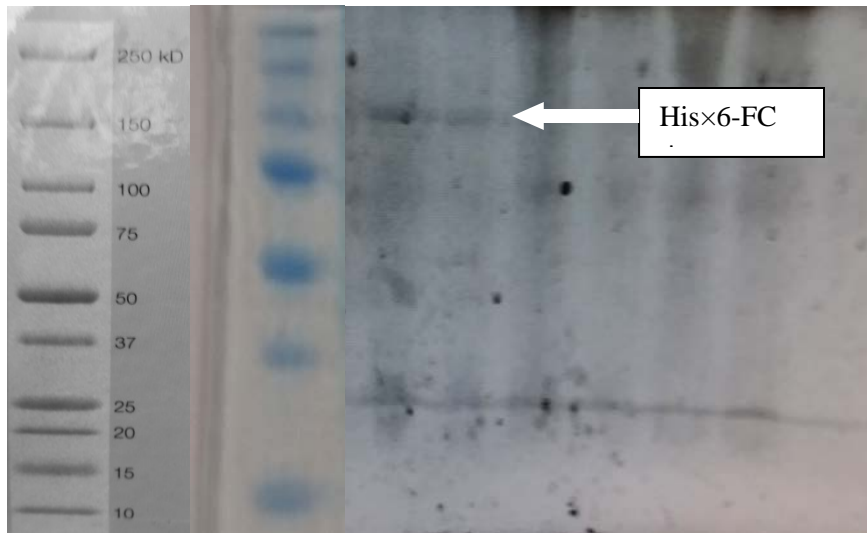
After that the GFP gene of pGFPuv was restricted out and replaced by His×6-FC fragment in pAEM-2. For confirmation, pAEM-2His×6-FC was recovered from *P. fluorescens* and *E. coli*. Two bands were seen after restricted by *ApaI* and *XbaI* from both bacteria in lane three and lane five; respectively (Fig. 5-11).



**Figure 5-11.** His×6FC gene showed in lanes 3 and 5 after treated with *ApaI* and *XbaI* from *P. fluorescens* and *E. coli*; respectively. Lane 7 presents whole His×6FC containing pAEM-2.

### 5.9 Detection of His×6-FC by protein tag stain reagent set:

This method does not need to purify protein first. Intracellular proteins that were extracted from the bacteria by sonication are directly examined. According to instructions, the reagents are able to detect a histidine tagged protein (without previous staining) at a concentration of as low as 0.2  $\mu\text{g}$  of a 35KDa using a CCD camera. As shown in Figure 5-12, only two bands of FC that tagged with histidine are present whereas, other protein shown only after the gel had been treated with Coomassie stain.



**Figure 5-12. Electrophoresis of extracts containing His6-FC detected by CCD camera.**

## 6. Conclusions

1. *Pseudomonas fluorescens* was successfully grown in a batch fermenter, demonstrating the bacterium could be grown to sufficient optical density to be an attractive alternative to *E. coli* as a recombinant host. Although not examined in this study, one rationale to choose *P. fluorescens* over the *E. coli* is the fact that this soil bacterium may display less burden on downstream processing in terms of endotoxicity.
2. Plasmids were constructed by taking elements from a vector originally designed to examine promoter efficiency in *P. fluorescens*. An IPTG-inducible cassette was incorporated into pBBR1mcs-3 which was used to overexpress Green Fluorescent Protein as a model protein. This portion of the study demonstrated recombinant protein production is possible with this host.
3. DEAE of soluble protein from wild type *P. fluorescens* identified the most abundant HCPs that would be encountered during bioseparation via ion exchange chromatography. The large number of essential proteins indicated that gene repression may be a better strategy than simple gene knockout.
4. Transformation of *P. fluorescens* with a plasmid bearing a ColE1/pUC origin and the gene for Fragment C (FC) of *Clostridium tetani* demonstrated the potential of using existing plasmids with this organism. To our knowledge, this is the first report of the use of this strain to produce FC of tetanus toxoid.

## 7. Recommendations

1. Use CRISPR to reduce level of essential host cell proteins because simple knockout will likely kill or impair *P. fluorescens*.
2. Compare endotoxicity of FC derived from *E. coli* and *P. fluorescens*.
3. While these studies demonstrate *P. fluorescens* is capable of recombinant protein expression, a direct comparison to *E. coli* was not made. Therefore, it would be instructive to compare total expression level of GFPuv, for example, contained in extracts of each.

## 7. References

- Abbott, A. (1999). A post-genomic challenge: learning to read patterns of protein synthesis. *Nature*, 402(6763), 715–20. <http://doi.org/10.1038/45350>
- Anderson, L., & Seilhamer, J. (1997). A comparison of selected mRNA and protein abundances in human liver. *Electrophoresis*, 18(3–4), 533–7. <http://doi.org/10.1002/elps.1150180333>
- Andersson, C. (2000). Production and delivery of recombinant subunit vaccines. *Bioteknologi*. Retrieved from <http://www.diva-portal.org/smash/record.jsf?pid=diva2%3A8775&dswid=8002>
- Baldassi, L. (2005). Clostridial toxins: potent poisons, potent medicines. *Journal of Venomous Animals and Toxins Including ...* Retrieved from [http://www.scielo.br/scielo.php?pid=S1678-91992005000400002&script=sci\\_arttext&tlng=es](http://www.scielo.br/scielo.php?pid=S1678-91992005000400002&script=sci_arttext&tlng=es)
- Bauer, A. W., Kirby, W. M., Sherris, J. C., & Turck, M. (1966). Antibiotic susceptibility testing by a standardized single disk method. *American Journal of Clinical Pathology*, 45(4), 493–6. Retrieved from <http://www.ncbi.nlm.nih.gov/pubmed/5325707>
- BERTANI, G. (1951). Studies on lysogenesis. I. The mode of phage liberation by lysogenic *Escherichia coli*. *Journal of Bacteriology*, 62(3), 293–300. Retrieved from <http://www.ncbi.nlm.nih.gov/pubmed/14888646>
- Blencowe, H., Lawn, J., & Vandelaer, J. (2010). Tetanus toxoid immunization to reduce mortality from neonatal tetanus. *International Journal of ...* Retrieved from [https://ije.oxfordjournals.org/content/39/suppl\\_1/i102.full](https://ije.oxfordjournals.org/content/39/suppl_1/i102.full)
- Bloemberg, G. V., Wijfjes, A. H. M., Lamers, G. E. M., Stuurman, N., & Lugtenberg, B. J. J. (2007). Simultaneous Imaging of *Pseudomonas fluorescens* WCS365 Populations Expressing Three Different Autofluorescent Proteins in the Rhizosphere: New Perspectives for Studying Microbial Communities. <http://dx.doi.org/10.1094/MPMI.2000.13.11.1170>.
- Bromuro, C., Romano, M., Chiani, P., Berti, F., Tontini, M., Proietti, D., ... Cassone, A. (2010). Beta-glucan-CRM197 conjugates as candidates antifungal vaccines. *Vaccine*, 28(14), 2615–2623. <http://doi.org/10.1016/j.vaccine.2010.01.012>
- Buell, C. R., Joardar, V., Lindeberg, M., Selengut, J., Paulsen, I. T., Gwinn, M. L., ... Collmer, A. (2003). The complete genome sequence of the *Arabidopsis* and tomato pathogen *Pseudomonas syringae* pv. tomato DC3000. *Proceedings of the National Academy of Sciences of the United States of America*, 100(18), 10181–6. <http://doi.org/10.1073/pnas.1731982100>
- Chaga, G., Hopp, J., & Nelson, P. (1999). Immobilized metal ion affinity chromatography on Co<sup>2+</sup>-carboxymethylaspartate–agarose Superflow, as demonstrated by one-step purification of lactate. *Biotechnology and Applied*. Retrieved from <http://onlinelibrary.wiley.com/doi/10.1111/j.1470-8744.1999.tb01144.x/full>
- Cohen, S. N., Chang, A. C., Boyer, H. W., & Helling, R. B. (1973). Construction of biologically

functional bacterial plasmids in vitro. *Proceedings of the National Academy of Sciences of the United States of America*, 70(11), 3240–4. Retrieved from <http://www.pubmedcentral.nih.gov/articlerender.fcgi?artid=427208&tool=pmcentrez&rendertype=abstract>

- Crowe, J., Dobeli, H., Gentz, R., Hochuli, E., & Stüber, D. (1994). 6xHis-Ni-NTA Chromatography as a Superior Technique in Recombinant Protein Expression/Purification. *Protocols for Gene*. Retrieved from <http://link.springer.com/protocol/10.1385/0-89603-258-2:371>
- De Leo, F., Panarese, S., Gallerani, R., & Ceci, L. (2009). Angiotensin Converting Enzyme (ACE) Inhibitory Peptides: Production and Implementation of Functional Food. *Current Pharmaceutical Design*, 15(31), 3622–3643. <http://doi.org/10.2174/138161209789271834>
- Diane M. Retallack, Lawrence Chew, Hongfan Jin, H. W. T. (2011). High level expression of recombinant. *Cellular and Molecular Immunology*, 1–24.
- Dong, X.-Y., Feng, X.-D., & Sun, Y. (2010). His-tagged protein purification by metal-chelate affinity extraction with nickel-chelate reverse micelles. *Biotechnology Progress*, 26(4), n/a-n/a. <http://doi.org/10.1002/btpr.428>
- Downes, D. (1993). New Diplomacy for the Biodiversity Trade: Biodiversity, Biotechnology, and Intellectual Property in the Convention on Biological Diversity. *Touro J. Transnat'l L*. Retrieved from [http://heinonlinebackup.com/hol/cgi-bin/get\\_pdf.cgi?handle=hein.journals/touint4&section=4](http://heinonlinebackup.com/hol/cgi-bin/get_pdf.cgi?handle=hein.journals/touint4&section=4)
- Drury, L. (1994). Transformation of bacteria by electroporation. *Methods in Molecular Biology (Clifton, N.J.)*, 31, 1–8. <http://doi.org/10.1385/0-89603-258-2:1>
- Eisenberg, D., Marcotte, E. M., Xenarios, I., & Yeates, T. O. (2000). Protein function in the post-genomic era. *Nature*, 405(6788), 823–6. <http://doi.org/10.1038/35015694>
- Eith, C., Kolb, M., Seubert, A., & Viehweger, K. (2001). Practical ion chromatography. ... Ltd., Herisau, Switzerland. Retrieved from <https://web.psau.edu.sa/filedownload/doc-8-pdf-54996ced8ec545754b9c7404027969d8-original.pdf>
- Ereky, K. (1919). Biotechnologie der fleisch-, fett-und milcherzeugung im landwirtschaftlichen grossbetriebe für naturwissenschaftlich gebildete landwirte, verfasst. Retrieved from <http://agris.fao.org/agris-search/search.do?recordID=US201300272506>
- Etoc, A., Delvigne, F., Lecomte, J. P., & Thonart, P. (2006). Foam Control in Fermentation Bioprocess. *Applied Biochemistry and Biotechnology*, 130(1–3), 392–404. <http://doi.org/10.1385/ABAB:130:1:392>
- Fairweather, N., & Lyness, V. (1986). Cloning, nucleotide sequencing, and expression of tetanus toxin fragment C in Escherichia coli. *Journal of ...*. Retrieved from <http://jfb.asm.org/content/165/1/21.short>
- Fári, M., & Kralovánszky, U. (2006). The founding father of biotechnology: Károly (Karl) Ereky. *International Journal of Horticultural ...*. Retrieved from

[http://www.agrarkutatas.net/files/aktualis/pdf\\_agroinform\\_20070215112311\\_02Fari.pdf](http://www.agrarkutatas.net/files/aktualis/pdf_agroinform_20070215112311_02Fari.pdf)

- Fenn, J., Mann, M., Meng, C., Wong, S., & Whitehouse, C. (1989). Electrospray ionization for mass spectrometry of large biomolecules. *Science*, 246(4926), 64–71. <http://doi.org/10.1126/science.2675315>
- Fersht, A. R. (Ed.). (2008). *Protein Science Encyclopedia*. Weinheim, Germany: Wiley-VCH Verlag GmbH & Co. KGaA. <http://doi.org/10.1002/9783527610754>
- Finehout, E. J., & Lee, K. H. (2004). An introduction to mass spectrometry applications in biological research. *Biochemistry and Molecular Biology Education : A Bimonthly Publication of the International Union of Biochemistry and Molecular Biology*, 32(2), 93–100. <http://doi.org/10.1002/bmb.2004.494032020331>
- Fitzsimmons, S. P., Clark, K. C., Wilkerson, R., & Shapiro, M. A. (2000). Inhibition of tetanus toxin fragment C binding to ganglioside G(T1b) by monoclonal antibodies recognizing different epitopes. *Vaccine*, 19(1), 114–121. [http://doi.org/10.1016/S0264-410X\(00\)00115-8](http://doi.org/10.1016/S0264-410X(00)00115-8)
- Ghrayeb, J., Kimura, H., Takahara, M., Hsiung, H., Masui, Y., & Inouye, M. (1984). Secretion cloning vectors in Escherichia coli. *The EMBO Journal*, 3(10), 2437–42. Retrieved from <http://www.ncbi.nlm.nih.gov/pubmed/6094184>
- Giannini, G., Rappuoli, R., & Ratti, G. (1984). The amino-acid sequence of two non-toxic mutants of diphtheria toxin: CRM45 and CRM197. *Nucleic Acids Research*. Retrieved from <http://nar.oxfordjournals.org/content/12/10/4063.short>
- Godbey, W. T. (2014). *An Introduction to Biotechnology. An Introduction to Biotechnology*. Elsevier. <http://doi.org/10.1016/B978-1-907568-28-2.00017-4>
- Graves, P. R., & Haystead, T. A. J. (2002). Molecular biologist's guide to proteomics. *Microbiology and Molecular Biology Reviews : MMBR*, 66(1), 39–63; table of contents. Retrieved from <http://www.ncbi.nlm.nih.gov/pubmed/11875127>
- Gygi, S. P., Rochon, Y., Franza, B. R., & Aebersold, R. (1999). Correlation between Protein and mRNA Abundance in Yeast. *Molecular and Cellular Biology*, 19(3), 1720–1730. <http://doi.org/10.1128/MCB.19.3.1720>
- Haas, D., & Keel, C. (2003). Regulation of antibiotic production in root-colonizing *Pseudomonas* spp. and relevance for biological control of plant disease. *Annual Review of Phytopathology*, 41, 117–53. <http://doi.org/10.1146/annurev.phyto.41.052002.095656>
- Habermehl, P., & Leroux-Roels, G. (2010). Combined Haemophilus influenzae type b and Neisseria meningitidis serogroup C (HibMenC) or serogroup C and Y-tetanus toxoid conjugate (and HibMenCY). *Human ...* Retrieved from <http://www.tandfonline.com/doi/abs/10.4161/hv.6.8.12154>
- Haff, L. (1994). Improved quantitative PCR using nested primers. *Genome Research*. Retrieved from <http://genome.cshlp.org/content/3/6/332.short>

- Halpern, J. L., Habig, W. H., Neale, E. A., & Stibitz, S. (1990). Cloning and expression of functional fragment C of tetanus toxin. *Infection and Immunity*.
- Heid, C. A., Stevens, J., Livak, K. J., & Williams, P. M. (1996). Real time quantitative PCR. *Genome Research*, 6(10), 986–994. <http://doi.org/10.1101/gr.6.10.986>
- Herreros, J., LALLI, G., & SCHIAVO, G. (2000). C-terminal half of tetanus toxin fragment C is sufficient for neuronal binding and interaction with a putative protein receptor. *Biochemical Journal*. Retrieved from <http://www.biochemj.org/content/347/1/199.abstract>
- Higuchi, R., Dollinger, G., Walsh, P., & Griffith, R. (1992). Simultaneous amplification and detection of specific DNA sequences. *Bio/technology*. Retrieved from <http://www.gene-quantification.de/higuchi-1992.pdf>
- Hill, D. S., Stein, J. I., Torkewitz, N. R., Morse, A. M., Howell, C. R., Pachlatko, J. P., ... Ligon, J. M. (1994). Cloning of genes involved in the synthesis of pyrrolnitrin from *Pseudomonas fluorescens* and role of pyrrolnitrin synthesis in biological control of plant disease. *Applied and Environmental Microbiology*, 60(1), 78–85.
- Hirano, S. S., & Upper, C. D. (2000). Bacteria in the leaf ecosystem with emphasis on *Pseudomonas syringae*-a pathogen, ice nucleus, and epiphyte. *Microbiology and Molecular Biology Reviews : MMBR*, 64(3), 624–53. Retrieved from <http://www.ncbi.nlm.nih.gov/pubmed/10974129>
- Hochuli, E., Bannwarth, W., Dobeli, H., Gentz, R., & Stuber, D. (1988). Genetic approach to facilitate purification of recombinant proteins with a novel metal chelate adsorbent. *Bio/technology*. Retrieved from <http://cat.inist.fr/?aModele=afficheN&cpsidt=7229670>
- Hochuli, E., Döbeli, H., & Schacher, A. (1987). New metal chelate adsorbent selective for proteins and peptides containing neighbouring histidine residues. *Journal of Chromatography A*. Retrieved from <http://www.sciencedirect.com/science/article/pii/S0021967300939694>
- Howell, C. R., & Stipanovic, R. D. (1979). Control of *Rhizoctonia solani* on cotton seedlings with *Pseudomonas fluorescens* and with an antibiotic produced by the bacterium. *Phytopathology (USA)*. Retrieved from <http://agris.fao.org/agris-search/search.do?recordID=US7924449>
- Jackson, D. A., Symons, R. H., & Berg, P. (1972). Biochemical method for inserting new genetic information into DNA of Simian Virus 40: circular SV40 DNA molecules containing lambda phage genes and the galactose operon of *Escherichia coli*. *Proceedings of the National Academy of Sciences of the United States of America*, 69(10), 2904–9. Retrieved from <http://www.pubmedcentral.nih.gov/articlerender.fcgi?artid=389671&tool=pmcentrez&rendertype=abstract>
- Janknecht, R., Martynoff, G. De, & Lou, J. (1991). Rapid and efficient purification of native histidine-tagged protein expressed by recombinant vaccinia virus. *Proceedings of the*. Retrieved from <http://www.pnas.org/content/88/20/8972.short>



- Jin, H., Cantin, G. T., Maki, S., Chew, L. C., Resnick, S. M., Ngai, J., & Retallack, D. M. (2011). Soluble periplasmic production of human granulocyte colony-stimulating factor (G-CSF) in *Pseudomonas fluorescens*. *Protein Expression and Purification*, 78(1), 69–77. <http://doi.org/10.1016/j.pep.2011.03.002>
- Johnson, I. S. (1983). Human insulin from recombinant DNA technology. *Science (New York, N.Y.)*, 219(4585), 632–637. <http://doi.org/10.1126/science.6337396>
- Jørgensen, S., Skov, K., & Diderichsen, B. (1991). Cloning, sequence, and expression of a lipase gene from *Pseudomonas cepacia*: lipase production in heterologous hosts requires two *Pseudomonas* genes. *Journal of Bacteriology*. Retrieved from <http://jlb.asm.org/content/173/2/559.short>
- Joshi, M., & Deshpande, J. (2011). Polymerase chain reaction: methods, principles and application. *International*. Retrieved from <http://ssjournals.com.md-in-1.webhostbox.net/index.php/ijbr/article/view/640>
- Ju, J., Yokoigawa, K., Misono, H., & Ohnishi, K. (2005). Cloning of alanine racemase genes from *Pseudomonas fluorescens* strains and oligomerization states of gene products expressed in *Escherichia coli*. *Journal of Bioscience and Bioengineering*, 100(4), 409–417. <http://doi.org/10.1263/jbb.100.409>
- Karas, M., & Hillenkamp, F. (1988). Laser desorption ionization of proteins with molecular masses exceeding 10,000 daltons. *Analytical Chemistry*, 60(20), 2299–2301. <http://doi.org/10.1021/ac00171a028>
- Keen, H., Pickup, J., Bilous, R., & Glynn, A. (1980). Human insulin produced by recombinant DNA technology: safety and hypoglycaemic potency in healthy men. *The Lancet*. Retrieved from <http://www.sciencedirect.com/science/article/pii/S0140673680904432>
- Kennell, D., & Riezman, H. (1977). Transcription and translation initiation frequencies of the *Escherichia coli* lac operon. *Journal of Molecular Biology*, 114(1), 1–21. [http://doi.org/10.1016/0022-2836\(77\)90279-0](http://doi.org/10.1016/0022-2836(77)90279-0)
- Khlebnikov, A., Risa, O., Skaug, T., Carrier, T. A., & Keasling, J. D. (2000). Regulatable Arabinose-Inducible Gene Expression System with Consistent Control in All Cells of a Culture. *Journal of Bacteriology*, 182(24), 7029–7034. <http://doi.org/10.1128/JB.182.24.7029-7034.2000>
- Korz, D. J., Rinas, U., Hellmuth, K., Sanders, E. A., & Deckwer, W.-D. (1995). Simple fed-batch technique for high cell density cultivation of *Escherichia coli*. *Journal of Biotechnology*, 39(1), 59–65. [http://doi.org/10.1016/0168-1656\(94\)00143-Z](http://doi.org/10.1016/0168-1656(94)00143-Z)
- Kovach, M., Elzer, P., Hill, D., & Robertson, G. (1995). Four new derivatives of the broad-host-range cloning vector pBBR1MCS, carrying different antibiotic-resistance cassettes. *Gene*. Retrieved from <http://www.sciencedirect.com/science/article/pii/0378111995005841>
- KRAUS, J., & LOPER, J. E. (1992). Lack of evidence for a role of antifungal metabolite production by *Pseudomonas fluorescens* Pf-5 in biological control of *Pythium* damping-off

- of cucumber. *Phytopathology*, 82(3), 264–271. Retrieved from <http://cat.inist.fr/?aModele=afficheN&cpsidt=5319218>
- Kussmann, M., Panchaud, A., & Affolter, M. (2010). Proteomics in nutrition: status quo and outlook for biomarkers and bioactives. *Journal of Proteome Research*, 9(10), 4876–87. <http://doi.org/10.1021/pr1004339>
- Lander, E. S., Linton, L. M., Birren, B., Nusbaum, C., Zody, M. C., Baldwin, J., ... Szustakowki, J. (2001). Initial sequencing and analysis of the human genome. *Nature*, 409(6822), 860–921. <http://doi.org/10.1038/35057062>
- Lerner, C. G., & Inouye, M. (1990). Low copy number plasmids for regulated low-level expression of cloned genes in Escherichia coli with blue/white insert screening capability. *Nucleic Acids Research*, 18(15), 4631. Retrieved from <http://www.ncbi.nlm.nih.gov/pubmed/2201955>
- Liu, L., Oza, S., Hogan, D., Perin, J., Rudan, I., Lawn, J. E., ... Black, R. E. (2014). Global, regional, and national causes of child mortality in 2000–13, with projections to inform post-2015 priorities: an updated systematic analysis. *The Lancet*, 385(9966), 430–440. [http://doi.org/10.1016/S0140-6736\(14\)61698-6](http://doi.org/10.1016/S0140-6736(14)61698-6)
- Lloyd, J. R., & Bunch, A. W. (1996). The physiological state of an ethylenogenic Escherichia coli immobilized in hollow-fiber bioreactors. *Enzyme and Microbial Technology*, 18(2), 113–120. [http://doi.org/10.1016/0141-0229\(95\)00077-1](http://doi.org/10.1016/0141-0229(95)00077-1)
- Loper, J. E., Hassan, K. A., Mavrodi, D. V., Davis, E. W., Lim, C. K., Shaffer, B. T., ... Paulsen, I. T. (2012). Comparative Genomics of Plant-Associated Pseudomonas spp.: Insights into Diversity and Inheritance of Traits Involved in Multitrophic Interactions. *PLoS Genetics*, 8(7), e1002784. <http://doi.org/10.1371/journal.pgen.1002784>
- Luo, Z. Q., & Farrand, S. K. (1999). Cloning and characterization of a tetracycline resistance determinant present in Agrobacterium tumefaciens C58. *Journal of Bacteriology*, 181(2), 618–26. Retrieved from <http://www.pubmedcentral.nih.gov/articlerender.fcgi?artid=93418&tool=pmcentrez&render type=abstract>
- Mallick, P., Schirle, M., Chen, S. S., Flory, M. R., Lee, H., Martin, D., ... Aebersold, R. (2007). Computational prediction of proteotypic peptides for quantitative proteomics. *Nature Biotechnology*, 25(1), 125–31. <http://doi.org/10.1038/nbt1275>
- Mamedov, T. G., Pienaar, E., Whitney, S. E., TerMaat, J. R., Carvill, G., Goliath, R., ... Viljoen, H. J. (2008). A fundamental study of the PCR amplification of GC-rich DNA templates. *Computational Biology and Chemistry*, 32(6), 452–7. <http://doi.org/10.1016/j.compbiolchem.2008.07.021>
- Marbach, A., & Bettenbrock, K. (2012). lac operon induction in Escherichia coli: Systematic comparison of IPTG and TMG induction and influence of the transacetylase LacA. *Journal of Biotechnology*, 157(1), 82–8. <http://doi.org/10.1016/j.jbiotec.2011.10.009>

- Medaglini, D., Ciabattini, A., Spinosa, M. R., Maggi, T., Marcotte, H., Oggioni, M. R., & Pozzi, G. (2001). Immunization with recombinant *Streptococcus gordonii* expressing tetanus toxin fragment C confers protection from lethal challenge in mice. *Vaccine*, *19*(15–16), 1931–1939. [http://doi.org/10.1016/S0264-410X\(00\)00434-5](http://doi.org/10.1016/S0264-410X(00)00434-5)
- Minor, P. (2015). Live attenuated vaccines: Historical successes and current challenges. *Virology*. Retrieved from <http://www.sciencedirect.com/science/article/pii/S0042682215001725>
- Motamedi, H. (2011). Cloning and expression of tetanus toxin C fragment (Fc) in prokaryotic vector for constructing recombinant protein based vaccine for tetanus. *Iranian Journal of ...*. Retrieved from [http://ijvr.shirazu.ac.ir/article\\_49\\_12.html](http://ijvr.shirazu.ac.ir/article_49_12.html)
- Mrazek, J., and Summers, A. (2008). *Computational Methods for Understanding Bacterial and Archaeal Genomes*. World Scientific. Retrieved from <https://books.google.com/books?hl=en&lr=&id=yl67CgAAQBAJ&pgis=1>
- Naghmouchi, K., Le Lay, C., Baah, J., & Drider, D. (2012). Antibiotic and antimicrobial peptide combinations: synergistic inhibition of *Pseudomonas fluorescens* and antibiotic-resistant variants. *Research in Microbiology*, *163*(2), 101–8. <http://doi.org/10.1016/j.resmic.2011.11.002>
- Nedović, V., & Willaert, R. (Eds.). (2004). *Fundamentals of Cell Immobilisation Biotechnology* (Vol. 8A). Dordrecht: Springer Netherlands. <http://doi.org/10.1007/978-94-017-1638-3>
- Nelson, K. E., Weinel, C., Paulsen, I. T., Dodson, R. J., Hilbert, H., Martins dos Santos, V. A. P., ... Fraser, C. M. (2002). Complete genome sequence and comparative analysis of the metabolically versatile *Pseudomonas putida* KT2440. *Environmental Microbiology*, *4*(12), 799–808. <http://doi.org/10.1046/j.1462-2920.2002.00366.x>
- Nicholl, D. S. T. (2008). *An Introduction to Genetic Engineering*. Cambridge University Press. Retrieved from <https://books.google.com/books?hl=en&lr=&id=g1v6WMHVkTgC&pgis=1>
- Notomi, T., Okayama, H., Masubuchi, H., Yonekawa, T., Watanabe, K., Amino, N., & Hase, T. (2000). Loop-mediated isothermal amplification of DNA. *Nucleic Acids Research*, *28*(12), E63. Retrieved from <http://www.pubmedcentral.nih.gov/articlerender.fcgi?artid=102748&tool=pmcentrez&rendertype=abstract>
- Nowak, R. (1994). Mining treasures from “junk DNA.” *Science*, *263*(5147), 608–610. <http://doi.org/10.1126/science.7508142>
- Obranić, S., Babić, F., & Maravić-Vlahoviček, G. (2013). Improvement of pBBR1MCS plasmids, a very useful series of broad-host-range cloning vectors. *Plasmid*, *70*(2), 263–7. <http://doi.org/10.1016/j.plasmid.2013.04.001>
- Ochman, H., Gerber, A., & Hartl, D. (1988). Genetic applications of an inverse polymerase chain reaction. *Genetics*. Retrieved from <http://www.genetics.org/content/120/3/621.short>
- Odjadjare, E. E., Igbinsosa, E. O., Mordi, R., Igere, B., Igeleke, C. L., & Okoh, A. I. (2012).

- Prevalence of multiple antibiotics resistant (MAR) *Pseudomonas* species in the final effluents of three municipal wastewater treatment facilities in South Africa. *International Journal of Environmental Research and Public Health*, 9(6), 2092–107. <http://doi.org/10.3390/ijerph9062092>
- Páca, J., & Grégr, V. (1976). Design and performance characteristics of a continuous multistage tower fermentor. *Biotechnology and Bioengineering*, 18(8), 1075–1090. <http://doi.org/10.1002/bit.260180805>
- Paine, J., Shipton, C., & Chaggar, S. (2005). Improving the nutritional value of Golden Rice through increased pro-vitamin A content. *Nature* .... Retrieved from <http://www.nature.com/nbt/journal/v23/n4/abs/nbt1082.html>
- Parr, S. R., Wilson, M. T., & Greenwood, C. (1974). The reaction of *Pseudomonas aeruginosa* cytochrome c oxidase with sodium metabisulphite ( Short Communication ). *Biochemical Journal*, 139(1), 273–276. <http://doi.org/10.1042/bj1390273>
- Paulsen, I. T., Press, C. M., Ravel, J., Kobayashi, D. Y., Myers, G. S. A., Mavrodi, D. V., ... Loper, J. E. (2005). Complete genome sequence of the plant commensal *Pseudomonas fluorescens* Pf-5. *Nature Biotechnology*, 23(7), 873–878. <http://doi.org/10.1038/nbt1110>
- Pegg, D. E. (2007). Principles of cryopreservation. *Methods in Molecular Biology (Clifton, N.J.)*, 368, 39–57. [http://doi.org/10.1007/978-1-59745-362-2\\_3](http://doi.org/10.1007/978-1-59745-362-2_3)
- Peng, R., Xiong, A., Li, X., Fuan, H., & Yao, Q. (2003). A  $\beta$ -endotoxin encoded in *Pseudomonas fluorescens* displays a high degree of insecticidal activity. *Applied Microbiology and Biotechnology*, 63(3), 300–306. <http://doi.org/10.1007/s00253-003-1343-2>
- Phelps, J. P., Dang, N., & Rasochova, L. (2007). Inactivation and purification of cowpea mosaic virus-like particles displaying peptide antigens from *Bacillus anthracis*. *Journal of Virological Methods*, 141(2), 146–53. <http://doi.org/10.1016/j.jviromet.2006.12.008>
- Pierce, J. D., Fakhari, M., Works, K. V, Pierce, J. T., & Clancy, R. L. (2007). Understanding proteomics. *Nursing & Health Sciences*, 9(1), 54–60. <http://doi.org/10.1111/j.1442-2018.2007.00295.x>
- Pohl, G., & Shih, I.-M. (2014). Principle and applications of digital PCR. *Expert Review of Molecular Diagnostics*, 4(1), 41–47. <http://doi.org/10.1586/14737159.4.1.41>
- Porath, J. (1992). Immobilized metal ion affinity chromatography. *Protein Expression and Purification*, 3(4), 263–281. [http://doi.org/10.1016/1046-5928\(92\)90001-D](http://doi.org/10.1016/1046-5928(92)90001-D)
- Prendergast, F. G., & Mann, K. G. (1978). Chemical and physical properties of aequorin and the green fluorescent protein isolated from *Aequorea forskålea*. *Biochemistry*, 17(17), 3448–53. Retrieved from <http://www.ncbi.nlm.nih.gov/pubmed/28749>
- Raaijmakers, J. M., Vlami, M., & Souza, J. T. de. (2002). Antibiotic production by bacterial biocontrol agents. *Antonie van Leeuwenhoek*, 81(1–4), 537–547. <http://doi.org/10.1023/A:1020501420831>

- Rahman, M. T., Uddin, M. S., Sultana, R., Moue, A., & Setu, M. (2013). Polymerase Chain Reaction (PCR): A Short Review. *Anwer Khan Modern Medical College Journal*, 4(1), 30–36. <http://doi.org/10.3329/akmmcj.v4i1.13682>
- Rathore, K., & Pinky, G. (2012). An Overview on Ion Exchange Chromatography. *IJARPB*. Retrieved from [http://www.ijarpb.com/pdf/vol\\_02/07.pdf](http://www.ijarpb.com/pdf/vol_02/07.pdf)
- Rychlik, W., Spencer, W. J., & Rhoads, R. E. (1990). Optimization of the annealing temperature for DNA amplification in vitro. *Nucleic Acids Research*, 18(21), 6409–12. Retrieved from <http://www.pubmedcentral.nih.gov/articlerender.fcgi?artid=332522&tool=pmcentrez&rendertype=abstract>
- Saiki, R., Scharf, S., Faloona, F., Mullis, K., Horn, G., Erlich, H., & Arnheim, N. (1985). Enzymatic amplification of beta-globin genomic sequences and restriction site analysis for diagnosis of sickle cell anemia. *Science*, 230(4732), 1350–1354. <http://doi.org/10.1126/science.2999980>
- Sanghi, D., & Tiwle, R. (n.d.). A DETAIL COMPREHENSIVE REVIEW ON VACCINES. *Imsear.li.mahidol.ac.th*. Retrieved from <http://imsear.li.mahidol.ac.th/bitstream/123456789/150410/1/ijrdlp2014v3n2p887.pdf>
- Sarniguet, A., Kraus, J., Henkels, M. D., Muehlchen, A. M., & Loper, J. E. (1995). The sigma factor sigma s affects antibiotic production and biological control activity of *Pseudomonas fluorescens* Pf-5. *Proceedings of the National Academy of Sciences*, 92(26), 12255–12259. <http://doi.org/10.1073/pnas.92.26.12255>
- Scapin, G. (2006). Structural Biology and Drug Discovery. *Current Pharmaceutical Design*, 12(17), 2087–2097. <http://doi.org/10.2174/138161206777585201>
- Siddiqui, I. A., Qureshi, S. A., Sultana, V., Ehteshamul-Haque, S., & Ghaffar, A. (2000). Biological control of root rot-root knot disease complex of tomato. *Plant and Soil*, 227(1–2), 163–169. <http://doi.org/10.1023/A:1026599532684>
- Silby, M. W., Cerdeño-Tárraga, A. M., Vernikos, G. S., Giddens, S. R., Jackson, R. W., Preston, G. M., ... Thomson, N. R. (2009). Genomic and genetic analyses of diversity and plant interactions of *Pseudomonas fluorescens*. *Genome Biology*, 10(5), R51. <http://doi.org/10.1186/gb-2009-10-5-r51>
- Srikanth, M. V., Sunil, S. A., Rao, N. S., Uhumwangho, M. U., & Ramana Murthy, K. V. (2010). Ion-Exchange Resins as Controlled Drug Delivery Carriers. *Journal of Scientific Research*, 2(3), 597. <http://doi.org/10.3329/jsr.v2i3.4991>
- STANIER, R. Y., PALLERONI, N. J., & DOUDOROFF, M. (1966). The Aerobic Pseudomonads a Taxonomic Study. *Journal of General Microbiology*, 43(2), 159–271. <http://doi.org/10.1099/00221287-43-2-159>
- Stover, C. K., Pham, X. Q., Erwin, A. L., Mizoguchi, S. D., Warrenner, P., Hickey, M. J., ... Olson, M. V. (2000). Complete genome sequence of *Pseudomonas aeruginosa* PAO1, an opportunistic pathogen. *Nature*, 406(6799), 959–64. <http://doi.org/10.1038/35023079>

- Strien, J., Sanft, J., & Mall, G. (2013). Enhancement of PCR amplification of moderate GC-containing and highly GC-rich DNA sequences. *Molecular Biotechnology*, 54(3), 1048–54. <http://doi.org/10.1007/s12033-013-9660-x>
- Tanaka, K., Waki, H., & Ido, Y. (1988). Protein and polymer analyses up to m/z 100 000 by laser ionization time-of-flight mass spectrometry. *Rapid ...* Retrieved from [http://masspec.scripps.edu/mshistory/timeline/time\\_pdf/1988\\_Tanaka2.pdf](http://masspec.scripps.edu/mshistory/timeline/time_pdf/1988_Tanaka2.pdf)
- Tseng, C.-P., & Montville, T. (1992). Enzymatic regulation of glucose catabolism by *Lactobacillus plantarum* in response to pH shifts in a chemostat. *Applied Microbiology and Biotechnology*, 36(6). <http://doi.org/10.1007/BF00172193>
- Valones, M., & Guimarães, R. (2009). Principles and applications of polymerase chain reaction in medical diagnostic fields: a review. *Brazilian Journal of ...* Retrieved from [http://www.scielo.br/scielo.php?pid=S1517-83822009000100001&script=sci\\_arttext](http://www.scielo.br/scielo.php?pid=S1517-83822009000100001&script=sci_arttext)
- Venter, J. C., Adams, M. D., Myers, E. W., Li, P. W., Mural, R. J., Sutton, G. G., ... Zhu, X. (2001). The sequence of the human genome. *Science (New York, N.Y.)*, 291(5507), 1304–51. <http://doi.org/10.1126/science.1058040>
- Vieira, J., & Messing, J. (1982). The pUC plasmids, an M13mp7-derived system for insertion mutagenesis and sequencing with synthetic universal primers. *Gene*. Retrieved from <http://www.sciencedirect.com/science/article/pii/0378111982900154>
- Vodovar, N., Vallenet, D., Cruveiller, S., Rouy, Z., Barbe, V., Acosta, C., ... Bocard, F. (2006). Complete genome sequence of the entomopathogenic and metabolically versatile soil bacterium *Pseudomonas entomophila*. *Nature Biotechnology*, 24(6), 673–9. <http://doi.org/10.1038/nbt1212>
- Walgren, J. L., & Thompson, D. C. (2004). Application of proteomic technologies in the drug development process. *Toxicology Letters*, 149(1–3), 377–85. <http://doi.org/10.1016/j.toxlet.2003.12.047>
- Wasinger, V. C., Cordwell, S. J., Cerpa-Poljak, A., Yan, J. X., Gooley, A. A., Wilkins, M. R., ... Humphrey-Smith, I. (1995). Progress with gene-product mapping of the Mollicutes: *Mycoplasma genitalium*. *Electrophoresis*, 16(1), 1090–1094. <http://doi.org/10.1002/elps.11501601185>
- Watson, J., & Crick, F. (1953). Molecular structure of nucleic acids. *Nature*. Retrieved from <http://www.nature.com/physics/looking-back/crick/>
- Wu, G., Feng, C., Hong, Y., Guo, A., Cao, S., Dong, J., ... Liu, Z. (2010). Soluble expression and purification of the anthrax protective antigen in *E. coli* and identification of a novel dominant-negative mutant N435C. *Applied Microbiology and Biotechnology*, 87(2), 609–16. <http://doi.org/10.1007/s00253-010-2495-5>
- Wunschel, D. S., Hill, E. A., McLean, J. S., Jarman, K., Gorby, Y. A., Valentine, N., & Wahl, K. (2005). Effects of varied pH, growth rate and temperature using controlled fermentation and batch culture on matrix assisted laser desorption/ionization whole cell protein fingerprints.

*Journal of Microbiological Methods*, 62(3), 259–71.  
<http://doi.org/10.1016/j.mimet.2005.04.033>

Wüthrich, K. (2001). The way to NMR structures of proteins. *Nature Structural Biology*, 8(11), 923–5. <http://doi.org/10.1038/nsb1101-923>

Yan, Y., Yang, J., Dou, Y., Chen, M., Ping, S., Peng, J., ... Jin, Q. (2008). Nitrogen fixation island and rhizosphere competence traits in the genome of root-associated *Pseudomonas stutzeri* A1501. *Proceedings of the National Academy of Sciences of the United States of America*, 105(21), 7564–9. <http://doi.org/10.1073/pnas.0801093105>

Yong Gao, \*, †, Barry W. Schafer, †, Randy A. Collins, †, Rod A. Herman, †, Xiaoping Xu, †, Jeffrey R. Gilbert, †, ... Tagliani †, L. A. (2004). Characterization of Cry34Ab1 and Cry35Ab1 Insecticidal Crystal Proteins Expressed in Transgenic Corn Plants and *Pseudomonas fluorescens*.

Yu, H., Ding, Y.-S., & Mou, S.-F. (2003). Some factors affecting separation and detection of amino acids by high-performance anion-exchange chromatography with integrated pulsed amperometric detection. *Journal of Chromatography A*, 997(1–2), 145–153.  
[http://doi.org/10.1016/S0021-9673\(03\)00116-X](http://doi.org/10.1016/S0021-9673(03)00116-X)

## Appendix I

### A. Summary of Phase I Results

#### 1. Background and Problem Definition

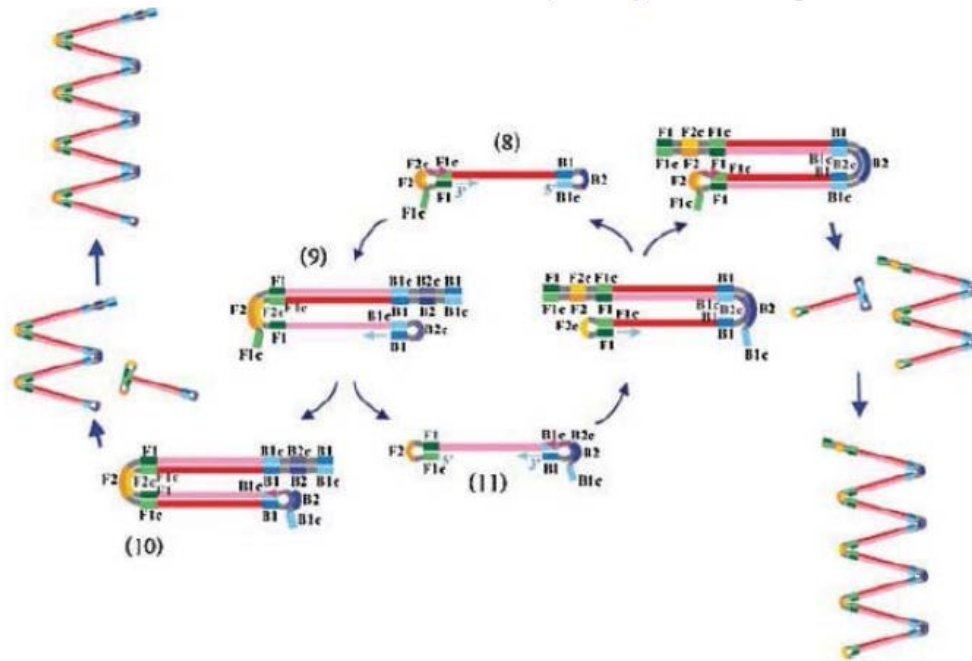
When testing water quality, “microbiological results typically require a minimum of 24 hours to complete”<sup>5</sup> due to reliance on the traditional and inexpensive cultivation method. For example, the Hach PathoScreen Medium Presence/Absence Powder Pillows, a simple presence-absence test to detect waterborne pathogens without the need for an incubator in warm climates, is approximately \$1.17 per test and requires 24-48 hours to complete.<sup>14</sup> Advancements in molecular biology in the past four decades has led to the development of more rapid methods of microbiological assessments. In the last two decades of the 20<sup>th</sup> century, polymerase chain reaction (PCR), a DNA replication method that is rapid (requiring a few hours to complete), sensitive, and specific, was invented.<sup>1</sup> PCR requires the use of a thermocycler, a traditionally expensive machine costing \$650-\$8,000, to alternate the temperature during the reaction. In 2000, an isothermal DNA amplification method termed loop-mediated isothermal amplification (LAMP) was invented allowing for microbiological assessments to be performed in less than one hour without the need for an expensive thermocycler.<sup>2</sup> In 2013, the World Health Organization reported LAMP as an “attractive diagnostic platform for resource-poor settings: it is fast (15-40 min), isothermal (requiring only a heat block), robust to inhibitors and reaction conditions that usually adversely affect PCR methods, and it generates a result that can be detected with the naked eye.”<sup>3</sup> Typically an electric heat block costing \$80-\$350 is used to maintain an isothermal temperature during LAMP reactions. The WHO report notes the need to consider operational issues such as a lack of continuous electricity supply, limited storage and bench space, and storage settings where temperatures are above the manufacturer’s recommendation when working in low-resource environments. As commercial LAMP assays begin to enter the market,<sup>4</sup> there is need for a low-cost, compact, and LAMP-specific heating block that can be used in resource-poor environments. Furthermore, there is a need to utilize LAMP and the heating block for resource-poor environments to decrease the time needed to test drinking water for microbes



at a price that competes with the traditional cultivation method. The use of LAMP for detecting microbes in water along with a heating block for resource-poor environments has the potential to advance people, prosperity, and the planet in developed and developing countries.

### **Background on LAMP**

LAMP is best understood by watching a short video located at <https://www.youtube.com/watch?v=ZXq756u1msE>. The basic tenet of LAMP relies on the unique capability of Bst polymerase to provide complementary strand synthesis while causing strand displacement, eliminating the requirement of changing temperatures for denaturation and annealing, as is necessary for conventional PCR<sup>6</sup>. LAMP requires six DNA primers that are easily designed based on complementary requirements. As LAMP proceeds, a single strand structure is formed that is self-complementary owing to two loop structures that are formed at the 5' and 3' end of the DNA molecule. Continued cycles generate a spectrum of sizes, not a single size as in conventional PCR, that contain multiple copies of the target being amplified. Within half an hour, the cycling reaction can amplify the target sequence up to 10<sup>9</sup> copies. The final products are stem-loop DNAs containing inverted repeats, and cauliflower-like shapes of alternating inverted repeats (**Figure 1**).



**Figure 1. Summary of LAMP [from 3].** Structure (8) is the self-complementary loop that forms the basis of LAMP. Subsequent rounds produce DNA of different lengths comprised of multimers of the sequence of interest.

### Background on chosen water-borne pathogen

Water pollution caused by fecal contamination is a serious problem due to the potential for contracting diseases from water-borne pathogens. Due to the wide range of water-borne pathogens, it is difficult and expensive to conduct a complete analysis for every type of pathogen.<sup>7</sup> As a result, the presence of pathogens is determined with indirect evidence by testing for an “indicator” organism. The presence of an “indicator” organism “does not guarantee that the water will cause an illness. Rather, their presence indicates that a contamination pathway exists between a source of bacteria (surface water, septic system, animal waste, etc.) and the water supply.”<sup>8</sup> Currently, “*E. coli* is considered... the best indicator of fecal pollution and the possible presence of pathogens”.<sup>7</sup> This P3 project investigated the utility of LAMP in water quality assessment by testing for the *ipaH* gene of enteroinvasive *E. coli* and *Shigella flexneri*, pathogenic bacteria that cause profuse diarrhea and high fever. In 1999, the WHO reported that “the annual number of *Shigella* episodes throughout the world was estimated to be 164.8 million,

of which 163.2 million were in developing countries.” It was estimated that *Shigella flexneri* was responsible for 60% and 16%, respectively, of *Shigella* episodes in developing and developed countries.<sup>9</sup>

### **Relationship to People, Prosperity and the Planet/Relevance and significance to developing and developing world**

#### **Benefit to people**

Each year more than 200 million people in developed and developing countries are affected by floods, earthquakes, and other natural disasters that often interrupt water and electricity services for extended periods.<sup>10</sup> Utilizing LAMP to detect *E. coli* and *Shigella* in a resource-poor environments has the potential to improve decision making regarding drinking water resources in disaster situations, resulting in better service to those affected.

#### **Promote prosperity**

As LAMP-based detection kits for endemic diseases common in developing countries enter the market<sup>5</sup>, a low-cost heating block for resource-poor environments has the potential to make the kits more appropriate for developing countries. Increasing access to LAMP-based detection in low-resource medical clinics could improve the quality of health care by allowing for same day diagnosis. Furthermore, in 2003, a study in Lebanon found that lack of access to clean water leads directly to a lack of productivity as high as >3% gross domestic product.<sup>11</sup> Overall, utilizing LAMP in resource-poor environments to detect endemic diseases and assess water quality will help prevent the spread of diseases. Maintaining a high quality of public health promotes prosperity in communities.

## **Protect the planet**

By 2050, the United Nations predicts that the population will increase by 2.4 billion people and that 85% of the global population will live in developing regions.<sup>12</sup> Currently, an estimated 1.8 billion people (25% of the population) lack adequate sanitation.<sup>13</sup> If substantial progress is not made in the sanitation sector, it is likely that water quality will continue to decline as the population density increases. The ability to cost-effectively monitor water quality in developing regions can help investigators determine when a water source becomes polluted. Awareness of pollution is the first step to developing an action plan to protect our planet's water resources.

## **Implementation of the P3 project as an educational tool**

Our P3 team contains five undergraduates, a biology major and four chemical engineering majors (one will receive a physics minor), who are supervised by a Ph.D. cell and molecular biology student and two (bio)chemical engineering faculty. The project forms the basis of honors thesis work for three of the students. Through working on the project, the students have applied knowledge and skills from a variety of fields, including chemical engineering, electrical engineering, and biology. Designing and building the prototype required knowledge of concepts such as heat transfer, heat capacity, materials, polymerase chain reaction, DNA-binding dyes, and the design of an electric heating component. All the students were involved in research, design, construction, and testing, but were divided into groups that focused on part of the overall design. This strategy allowed students to use their individual strengths. One group focused on the design and heating of the device, another found dyes and contributed designs for 3D printing using Solid Works, and a third group focused on designing and testing the PCR reaction. The groups met regularly to share progress and discuss ideas, and worked as a team to finish and test the prototypes. The team also collaborated with a local biotechnology company, NowDx, which gave students valuable experience in meeting and collaborating with professionals.

In designing the prototype, students had to balance multiple considerations including ease of use, accuracy, cost, and sustainability. Through the process of designing, testing, and redesigning the

device, students were guided by principles of sustainability, such as reusability and environmental impact. In order to reduce waste and operating cost, the P3 team decided to construct a reusable prototype which demonstrates the heating principle for the LAMP device. Another consideration was the environmental impact of disposable components, which included choosing a dye that is non-mutagenic, non-toxic, and does not harm aquatic life.

In addition to its contribution to the education of the undergraduates involved, this project will be used as a tool to educate K12 students in engineering, sustainability, and science. The device will be used as an example of how engineering and sustainable design work, and demonstrate how engineering decisions are impacted by environmental concerns. Additionally, this device will be used to demonstrate multiple scientific concepts such as DNA replication, melting and freezing points, heat transfer, electricity, and dyes.

Finally, this project was also accepted as a 2016 Clinton Global Initiative University (CGI U) Commitment to Action in the focus area of public health. Three undergraduate members of the research team will travel to Berkeley, California to represent this commitment to action. While at Berkeley, the students will participate in the CGI U Exchange, an exhibit where students and sponsors showcase their Commitments to Action and organizations to approximately 300 visitors. The students will present a poster of their EPA P3 research and give demonstrations on how LAMP and their heat block can be utilized to test for water-borne pathogens in resource-poor environments.

## **2. Purpose, Objectives, Scope**

The United Nations estimates that water-borne illness accounts for 80% of deaths in developing nations where nearly 1 in 6 do not have access to clean water [1]. Annually more than 200 million people in developed and developing countries are affected by floods, earthquakes, and other natural disasters that often interrupt water and electricity services for extended periods. As an example, consider the people of Louisiana and the impact of hurricane Katrina. During this

emergency, at minimum 2.4 million people were without access to safe drinking water [2]. When testing water quality, “microbiological results typically require a minimum of 24 hours to complete”<sup>5</sup> due to reliance on the traditional and inexpensive cultivation method. The World Health Organization describes LAMP as an “attractive diagnostic platform for resource-poor settings: it is fast (15-40 min), isothermal (requiring only a heat block), robust to inhibitors and reaction conditions that usually adversely affect PCR methods, and it generates a result that can be detected with the naked eye.” In 2011, Eiken Chemical Co. released the first LAMP-based tuberculosis detection kit designed to be simple enough and inexpensive enough to implement in resource-limited settings.<sup>1,15</sup> Two important considerations provide motivation for our P3 effort:

- Although LAMP reagent/assay kits have been developed for a number of infectious diseases, there has been limited focus on the development of LAMP-based diagnostic for water-borne pathogens, and
- LAMP-based diagnostic platforms traditionally rely on conventional-PCR devices which are bulky and not easily deployed in a resource-poor environment. A resource-poor environment is one that lacks access to electricity and lab equipment.

To wit, the overall objective of Phase I was to develop a low-cost, LAMP-based diagnostic platform capable of detecting the presence of water-borne pathogens in resource-poor environments by individuals with a modicum of formal training with the device. The principal technical objectives of Phase I included:

### **Heating (1)**

A method for providing heat to the device had to be designed and assessed.

### **Visualization (2)**

A dye that could provide a positive result when the water-borne agent is present had to be selected.

### **LAMP (3)**

A primer set for the model water-borne agent had to be designed for the ipaH gene shared in

enteroinvasive E.coli and Shigella flexina.

While there were three technical objectives proposed in Phase I of the project, the overarching goal was to construct a prototype capable of demonstrating effective temperature control for demonstration of LAMP.

### **3. Data, Findings, Outputs/Outcomes**

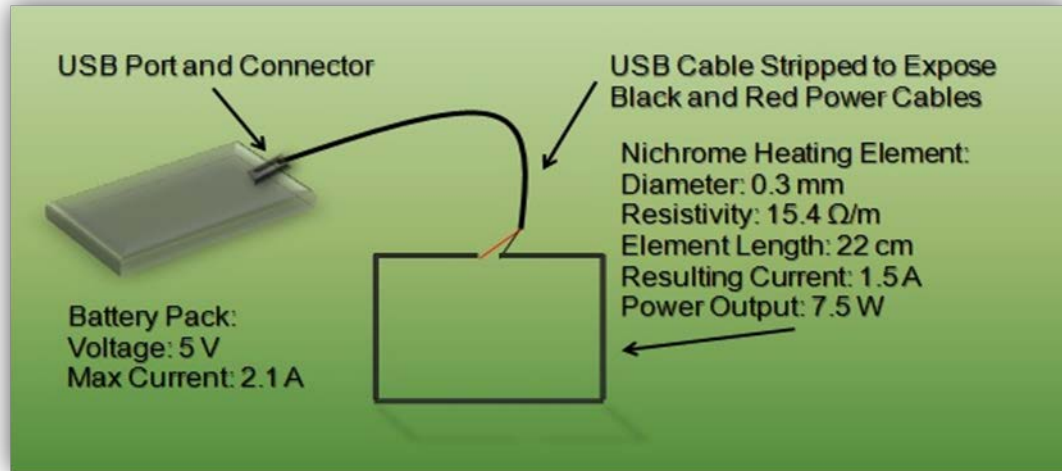
#### **Heating (1)**

The objective of the device is to heat a sample of water containing LAMP reagents to 65 °C such that DNA replication can be initiated and sustained for up to 45 minutes. Initially, three heating methods were considered: chemical heating, disposable microbatteries, and a rechargeable battery pack, the last method being chosen for this proposal. The case of the device is 3D-printed and contains a phase-change material, a heating wire, and a rack containing the water vials.

The rechargeable battery pack was chosen as an appropriate heating method because it minimizes waste, increases sustainability, and most importantly, may be recharged easily. In terms of waste / sustainability, while chemical heating methods like iron oxidation or forced crystallization are inexpensive and easily provide enough heat for a LAMP reaction, (i) the energy output cannot be precisely controlled, (ii) environmental factors like humidity and surrounding temperature cause these materials to fail, and most importantly (iii) require disposal when spent. Note that while microbatteries like the ones that are used to power GPS trackers in fish would provide improved control over power output, they do not provide nearly enough energy to sustain a LAMP reaction and still would require disposal of Cd or similar metal.

Our final heating device consisted of a battery pack that provides current through a nichrome heating wire via a USB cable. The USB connector provides attachment to the battery, and as will be described in our Phase II proposal, is integral to the plans we have for the next phase of the prototype. At a diameter of 0.3 mm, nichrome has a resistivity of 15.4  $\Omega$ /m so that the resulting current through the heating element is 1.5 A for a wire length of 22 cm. Since USB devices

operate at 5 V, the total power required of the device is a mere 7.5 W. **Figure 1** is an illustration of the circuit as well as its relevant physical values.



**Figure 1:** Illustration of the device's heating method

Once the heating method was chosen and constructed, the next phase of the development consisted of designing a housing capable of containing not only the nichrome element, but also a material that when used in the prototype virtually eliminates the need for thermocouple-based temperature control. As previously mentioned, virtually all useful LAMP-based detection methods still employ a PCR thermocycler. These devices, while capable of precise temperature control and cycling, use advanced process control and electronics to maintain temperature. In contrast, our prototype design uses a phase-change material to act as a thermal ballast. Phase-change materials are wax-like substances that upon initial melting, release heat as they are cooled back to a solid state. This solid / liquid transition provides excellent temperature control without the use of a thermocouple or ancillary electronics. In other words, the inclusion of phase-change material in the design greatly drives simplicity, which in turn keeps cost down and eliminates the use of electronics which eventually may end up in a landfill.

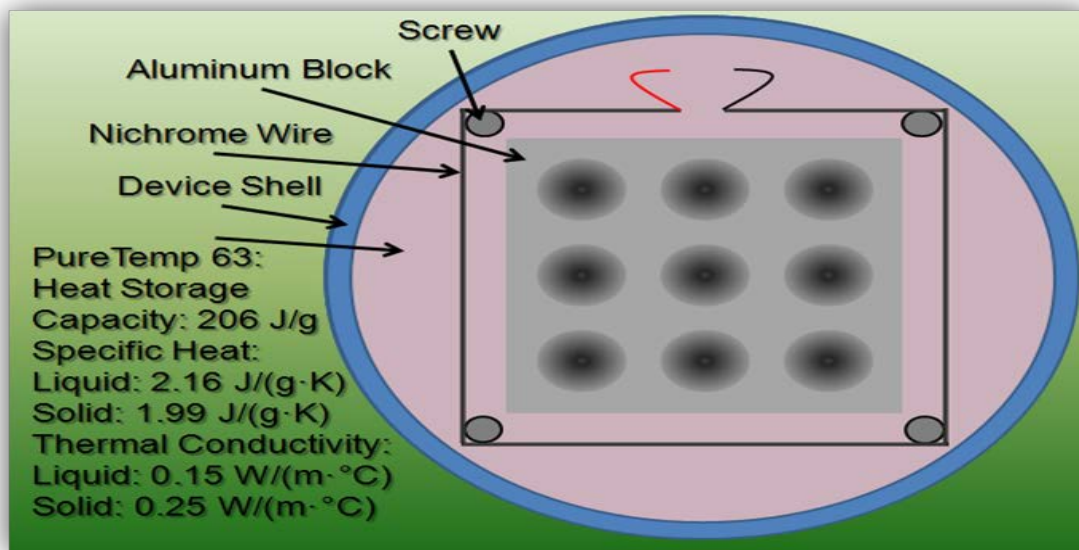
Several prototype devices were constructed via 3D printing and assessed for the following:



- Reasonable start-time required to melt the phase-change material obtained from Entropy Solutions LLC.
- Ability to monitor the melt transition visually.
- Ability to maintain temperature at a value capable of supporting LAMP.

With regards to the phase-change material, the company provided us with a material capable of maintaining 63 °C, which is a reasonable temperature for LAMP.

**Figure 2** is a diagram that provides a schematic of the first functional prototype. In addition to the phase-change material, prototype #1 included an aluminum heating block traditional to most PCR devices. The device was designed to hold nine small microcentrifuge tubes common to LAMP and conventional PCR.



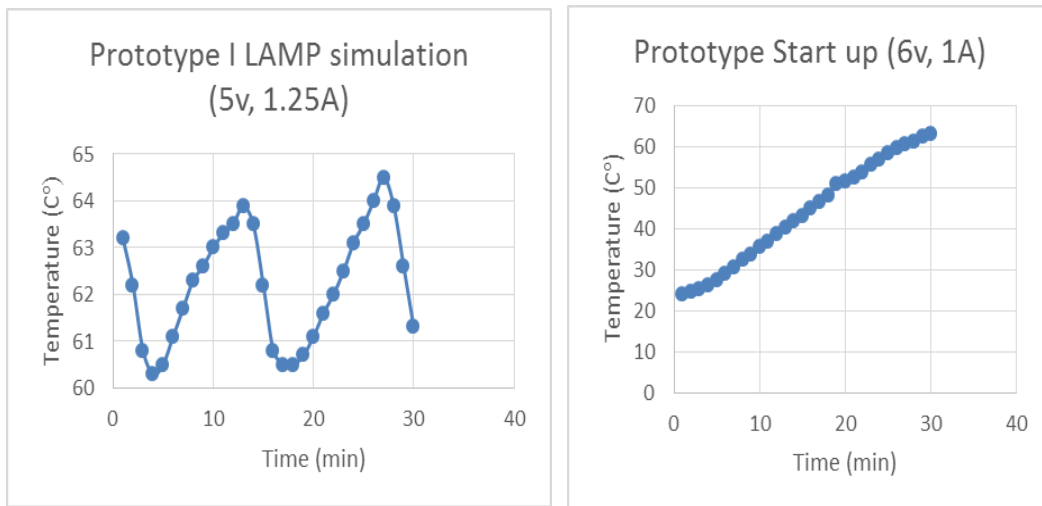
**Figure 2:** Functional Prototype #1

To examine the heating characteristics, the device temperature was raised to approximately 65 °C. Once the device reached this temperature, evident by the melting of the phase-change material, a 50- $\mu$ L Eppendorf tubes containing a water sample and thermocouple was placed in the aluminum block. During the test phase, the biosensor's temperature needs to be maintained

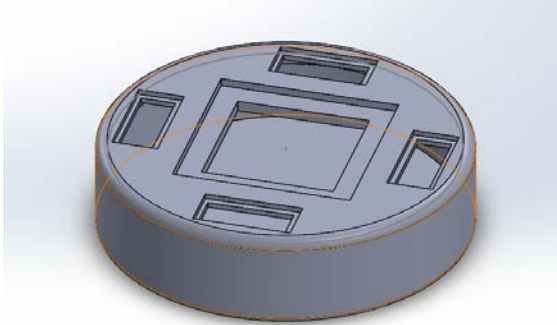
between 63-67 °C, a reliable range wherein DNA replication can occur. Temperature control is achieved simply by turning the battery pack on and off, observing the condition of the Phase-change material.

Examination of the temperature profile indicated a degree of success with the first prototype, as a temperature of 62 °C +/- 2 °C could be easily obtained. **Figure 3** illustrates one simulated LAMP cycle for thirty minutes. Other formats were examined but rejected because of long heat up times [ref]. The final functional prototype #1 (**Figure 4**) included the addition of a thermochromic material that changed from RED to CLEAR at 62 °C, a small round footprint, and metallized polyethylene terephthalate lining to help reduce heat loss. This device required approximately 30 minutes of startup heating (**Figure 2**).

Our first functional prototype, “hockey puck”, was determined to lose heat to the surroundings via the aluminum that surrounded the tubes and the four windows that allowed for observation of the phase-change material. A second functional prototype was printed that simply had holes for the microcentrifuge tubes, eliminating the aluminum block, and a single window (**Figure 5**).

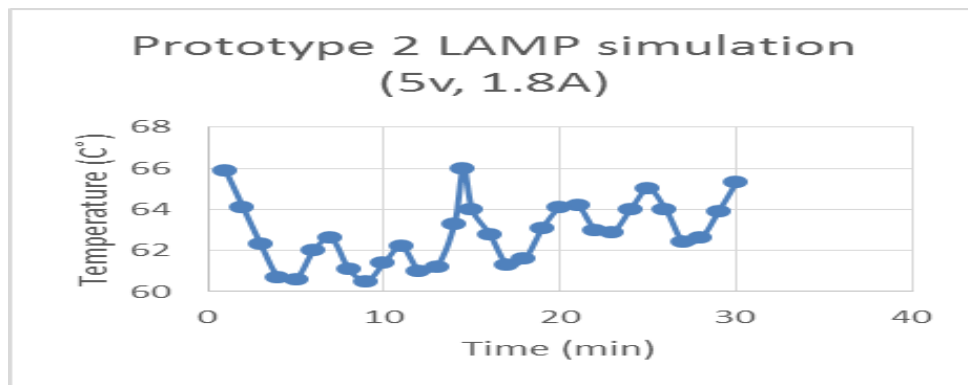


**Figure 3:** Temperature characterization of prototype #1

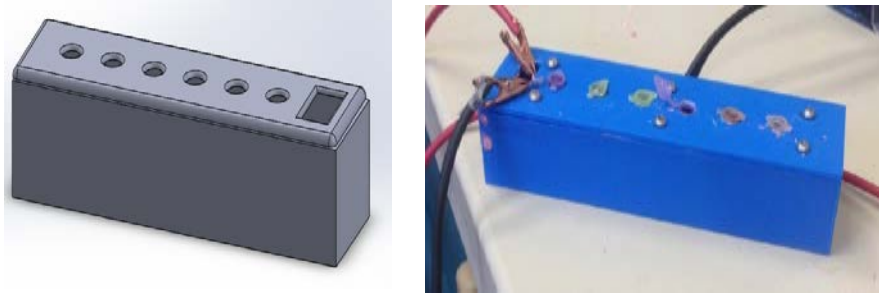


**Figure 4:** Hockey Puck functional prototype #1. Left panel is solid works rendering used to provide 3-D print instruction. Right panel is device.

The aluminum block was removed in prototype #2 and the PCR tubes were put directly into the phase change material. In order to evenly heat, the holes were aligned and the device was made taller. This design required slightly more wire, with half of the wire as nichrome and the other half copper. The nichrome wire acted as a resistor and gave off heat, while the copper simply conducted the charge. This modification to the wire cut down on the energy required to heat the phase change material to its desired temperature: 63 °C. This change made a significant impact in the time it took to heat the phase change material during start up and PCR.



**Figure 6:** Graph of temperature change over time during a 30-minute PCR using prototype #2.



**Figure 5:** Stick functional prototype #2. Left panel is solid works rendering used to provide 3-D print instruction. Right

Due to time constraints, a single temperature characterization was completed with prototype #2.

**Figure 6** demonstrates that this simple design maintained temperature,  $63\text{ }^{\circ}\text{C} \pm 2\text{ }^{\circ}\text{C}$ .

## Visualization (2)

Fluorescent dyes are the most common method of indicating the presence of DNA post-PCR.

The function of these dyes is to bind to the sugar-phosphate backbone of DNA: the chemical structure of the dye (a positively charged compound) adheres to the sugar-phosphate backbone of DNA (a negatively charged compound). When exposed to a certain wavelength of light – its excitation wavelength – the dye will emit a specific wavelength of light. Therefore, a sample containing DNA will exhibit a fluorescence which can be visually observed. Originally, the project aimed to use SYBR Green, a well-known and widely-used dye for DNA quantification purposes. However, a characteristic of the majority of fluorescent dyes – including SYBR Green – is their inhibition of the DNA replication process as a result of their bond to the chemical structure of DNA. In order to simplify the device and minimize steps in the LAMP process, a new dye – EvaGreen – was chosen that is specifically designed for PCR applications. This allowed the dye to be added to the solution pre-PCR with no inhibition of DNA replication. There are several unique characteristics of EvaGreen dye that make it useful for LAMP applications. The key property of EvaGreen is that it is less inhibitory toward PCR and less likely to cause nonspecific amplification. As a result, EvaGreen can be used at a much higher

concentration, resulting in a more robust signal and eliminating dye redistribution problems. The excitation and emission wavelengths of EvaGreen are comparable to commonly-used dyes: both are within the visible spectrum of light, making a sample containing DNA visible to the human eye. Another beneficial property of the dye is its safety for use and disposal. EvaGreen is non-mutagenic and non-cytotoxic; it is also completely cell-impermeable, a factor responsible for its low toxicity. These features are significant because typical DNA dyes like SYBR Green are powerful mutation enhancers, inhibiting the natural DNA repairing mechanism in cells. The toxicity of SYBR Green is associated with its ability to enter cells rapidly. Finally, EvaGreen is classified as nonhazardous for drain disposal, and is classified as nonhazardous to aquatic life. As a result, the selected dye is favorable for the intended use and provides secondary environmental advantages over standard fluorescent dyes.

To prove that EvaGreen is able to be visually observed, a standard was prepared with known quantities of DNA and dye. Concentrations of DNA ranged from 20uL to 0.1uL, and a constant 5uL of EvaGreen was added to every sample, totaling 25uL each sample. The standard shows that at relatively high concentrations of DNA, the visual signal is very strong and can be observed easily (**Figure 7**). At concentrations of DNA between 0.5uL and 0.1uL, the signal becomes visually unreadable. Thus, the target DNA range for PCR amplification is between 0.5uL and 1uL of DNA, which will make the sample easily observed.



**Figure 7:** EvaGreen standard.

### LAMP (3)

Since the ipaH gene is common to enteroinvasive *E.coli* and *S. flexina*, it was chosen as a measure of water-borne pathogen contamination. LAMP requires six DNA primers to amplify the DNA target. Primer Explorer was used to design six primer sets for ipaH. One set is included in **Table 1** as an example.

**Table 1. Representative set of ipaH primers.**

Primer Information									
1	ID:16	dimer(minimum)dG=-2.22							
label	5'pos	3'pos	len	Tm	5'dG	3'dG	GCrate	Sequence	
F3	73	92	20	60.36	-6.10	-6.24	0.50	GCTGGAAAACTCAGTGCCT	
B3	252	269	18	59.00	-5.02	-6.76	0.56	GGAACATTTCCCTGCCCA	
FIP			40						
BIP			42						
F2	106	125	20	60.53	-5.80	-4.66	0.50	ACAGCAGTCTTTCGCTGTTG	
F1c	152	171	20	65.57	-4.71	-6.18	0.65	CATGTGAGCGCGACACGGTC	
B2	222	241	20	60.74	-7.76	-4.17	0.50	AGCGCCGGTATCATTATCGA	
B1c	177	198	22	65.28	-4.59	-5.84	0.55	ATCTCCGAAAACCCCTCCTGGT	

### 4. Discussion, Conclusions, Recommendations

Our Phase I project demonstrated that virtually all electronic components of a LAMP-based water borne pathogen detection system may be constructed based on the unique properties of phase-change materials. The 3-D printed prototypes, envisioned to be close to a final design, cost less than \$5.00 in material cost, making this system attractive as a means to provide this method of testing to both point-of-care and/or low resource settings. If selected for Phase II, the group plans to test for ipaH in control (DNA only) and actual water samples, refine the prototype and develop a simple set of instructional material for its use in both classroom and real-world environments, and finally make the device available to healthcare professionals and those responsible for water quality assessment.

### 5. Assurance statement

The University of Arkansas, through the Provost and Vice Chancellor for Academic Affairs,

Academic Initiatives and Integrity strives to create a culture of honesty and personal and professional responsibility among its students, faculty and staff. As a community of scholars, we uphold academic integrity as foundational to appropriate conduct within the university setting. Academic Initiatives and Integrity manages outreach efforts for policy education and facilitates the University's process for alleged violations with the All University Academic Integrity Board. The Academic Integrity Policy was strictly followed throughout this project.

### **B. Continued work**

NowDX and the University of Arkansas will continue to develop the prototype into a portable LAMP device. P3 team member, Brandon Hart, will continue working on this project next year as a junior. This summer, he will be traveling to Ghana, Africa to do water purification research. He has been accepted into the Southern University and A&M College International Research Experiences for Students Global Research Activates in Sustainable Water Purification Program. During the program, he will be conducting research on removing harmful chemicals from water. The goal of the research is to make the water drinkable. He will be staying at the Kwame Nkrumah University of Science & Technology for four weeks before returning to the United States. During his stay, he will have the opportunity to perform a field test of our device. He will be visiting local villages that do not have a reliable source of clean water. This opportunity will allow him to take water samples from the current water sources for testing our device. Field experiments of our device will be a natural extension of his research in Ghana.

## Appendix II

### Biosensor design for infectious, water-borne agents

---

Robert R. Beitle<sup>(1)</sup>, Christa Hestekin<sup>(1)</sup>, and Ahmed Elmasheiti<sup>(1,2)</sup>

(1) Ralph E. Martin Department of Chemical Engineering, University of Arkansas, Fayetteville AR. (2) Cell and Molecular Biology Program, University of Arkansas, Fayetteville AR.

---

#### Abstract

This proposal to the Environmental Protection Agency P3 (EPA P3) program addresses the following objective:

Low cost, diagnostic platforms capable of detecting the presence of water borne agents can be developed to operate in a minimalist environment by individuals with a modicum of formal training with the device.

This objective is motivated by the fact that access to clean water is a top priority. Indeed, the United Nations estimates that water-borne illness accounts for 80% of deaths in developing nations where nearly 1 in 6 do not have access to clean water [1]. All nations have populations that are at risk during natural disasters and as an example consider the people of Louisiana and the impact of hurricane Katrina. During this emergency, at minimum 2.4 million people were without access to safe drinking water [2]. To this end, this proposal to the EPA P3 addresses the issue of clean water, **EPA-G2015-P3-Q4 – Water**, by developing improved methods of detection that can operate in a minimalist environment. For the purpose of this proposal, a minimalist environment is defined as a setting that has little or no infrastructure available (electricity in particular), and lacks access to equipment – even something as simple as a heating plate – when water quality is assessed. In Phase I, the team will develop a working model of a DNA based detection system capable of operating in a minimalist environment and determine its capabilities and sensitivity. We anticipate that a Phase II effort will be aided by a local company with expertise in diagnostic kit development to package the system in a small



format and distribute the platform for testing in places such as Belize, a country commonly visited by UA students who help with infrastructure development.

Our innovation relies on a systems approach to develop a DNA based detection system based on Loop Mediated Isothermal Amplification (LAMP) [3-5]. The chemistry associated with LAMP

can greatly simplify the deployment of PCR (polymerase chain reaction) as a diagnostic tool.

However, despite the fact that LAMP has been in existence for about five years, this molecular biochemistry innovation has not been broadly adopted. Designing a LAMP based method for water-borne agent(s) that is capable of operating without electricity or equipment will require a method to deliver the heat required for LAMP. This challenge can be overcome through the use of chemical methods of heat generation that require a modicum of reagents. Finally, detection of the (positive) result when the water-borne agent is present will require a visual response to eliminate the need for expensive DNA visualization equipment of spectroscopic means.

Fortunately, these three challenges – LAMP methodology, heating, and visualization – can be addressed by a novel combination briefly discussed in this proposal narrative.

We propose, if supported by the EPA P3 program, to make the project available to undergraduate students to fulfill the design requirements for a degree in chemical engineering, biological

engineering, or biomedical engineering. These students could begin working on the project at the University of Arkansas Fayetteville Campus as early as the proposed start date of August 2015. The requested funds of \$14,943 will be used for material and supplies to validate the molecular technique, heating, and visualization, and ultimately for travel to the P3 Expo in Washington DC.

A summary of the project is as follows:

The technical objective of Phase I is the development of a LAMP based detection method for two water-borne agents, and the design/construction of self-contained, single use units that could be constructed and field tested during Phase II. The innovative characteristics include lack of sophisticated equipment, elimination of electrical supply, ease of use, and small footprint. People, prosperity, and planet benefit from the proposed work via the assessment

of water quality used to determine the safety for consumption and the impact mankind has on a watershed, respectively. It is anticipated that the work will result in a design that will be able to visually detect the presence of water-borne pathogens and as such, will not require extensive training by the end user. Finally, pollution prevention and control is addressed by the project by ease of deployment.

Keywords: pathogen detection, water treatment

## **Research Plan**

### **Challenge Definition**

Introduction. Sensitive and robust means of water quality monitoring is paramount in today's society, with PCR-based techniques considered a gold standard due to high accuracy and sensitivity [ref]. However, current PCR-based methods for water quality monitoring have evolved under conditions that require equipment like thermocyclers, for example, making this technique virtually out of reach for broad use in countries developing infrastructure associated with potable drinking water. Additionally, during times of natural disaster access to laboratory facilities become limited and sometimes impossible, rendering PCR-based methods moot.

While it can be argued that one can "simply boil water to kill the pathogens", such a luxury may not be possible due to circumstances of socioeconomics and crisis, respectively, especially if one needs to choose between the basic necessities of warmth, water, and the cooking of food.

To this end, the overarching goal of the proposed P3 project is the development of a PCR-based

water quality test that can broadly be distributed.

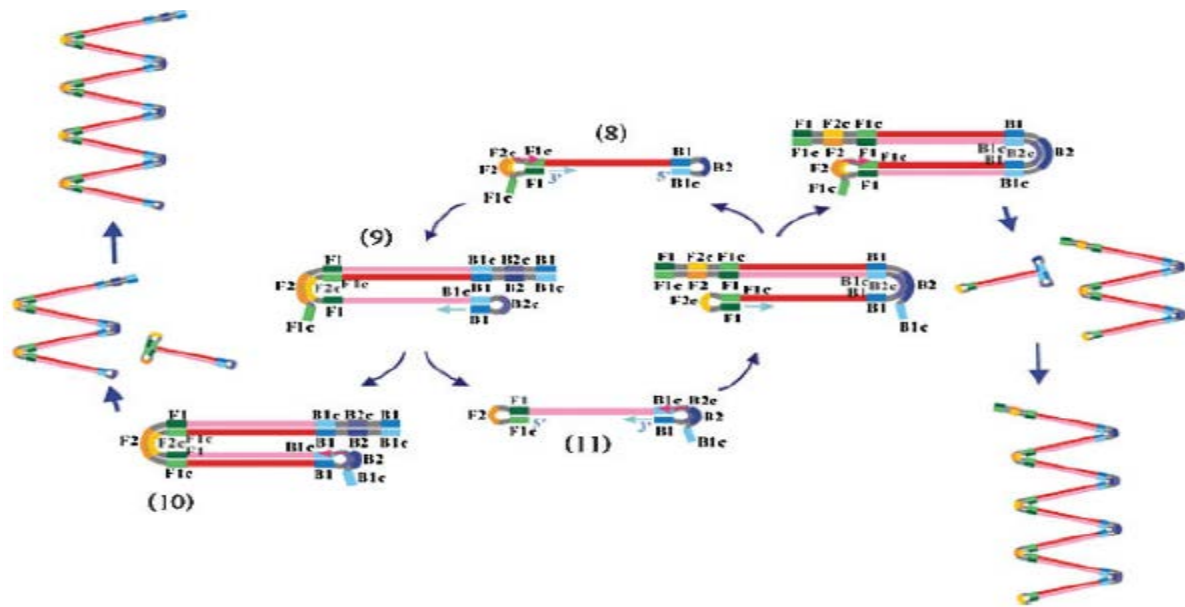
**Table 1. Summary of PCR techniques**

<b>Technique</b>	<b>Advantages</b>	<b>Disadvantages</b>
Conventional PCR	High sensitivity	Anneal, denature, and extension at different temperatures
Real-time PCR	High sensitivity Can detect RNA	Anneal, denature, and extension at different temperatures Requires reverse transcriptase in intermediate step
LAMP	High sensitivity Single temperature	Requires six primers, not two

The proposed P3 project will use LAMP as the basis for PCR. The principal advantage of LAMP, when compared to the two other conventional methods (**Table 1**), is the ability to drive amplification and strand displacement at a single temperature well below 100 °C. This advantage opens the possibility of deploying LAMP in the absence of a thermocycler. In keeping with the World Health Organization (WHO) guidelines towards operating in areas with no infrastructure or electricity, this single and low temperature requirement may allow the P3 team to develop a device similar to a “home pregnancy stick”. To demonstrate that the chemistry is feasible, the P3 team will choose two water-borne pathogens as models for the Phase I application, demonstrating that the DNA – **we will not work with live, infectious agents** – can be detected via this novel technology when approached from a systems standpoint that includes an assessment of molecular biochemistry, method of heating and method of visualization. This will set the stage for a Phase II application to address packaging and deployment.

Background on LAMP and detection methods. This novel means of PCR is best understood by watching a short video located at <https://www.youtube.com/watch?v=ZXq756u1msE>. The basic

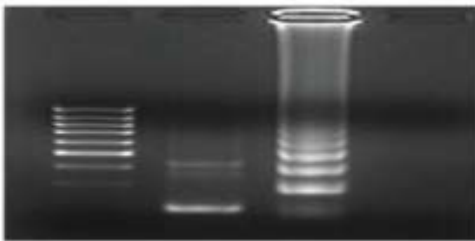
tenant of LAMP relies on the unique capability of Bst polymerase to provide complementary strand synthesis while causing strand displacement, eliminating the requirement of changing temperatures for denaturation and annealing [6]. LAMP requires six DNA primers, in contrast to two, that are easily designed based on complementary requirements. As LAMP proceeds, a single strand structure is formed that is self-complementary owing to two loop structures that are formed at the 5' and 3' end of the DNA molecule.



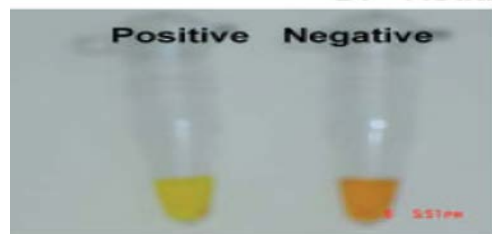
**Figure 1.** Summary of LAMP [from 3]. Structure (8) is the self-complementary loop that forms the basis of LAMP. Subsequent rounds produce DNA of different lengths comprised of multimers of the sequence of interest.

Continued cycles generate a spectrum of sizes, not a single size as in conventional PCR, that contain multiple copies of the target being amplified. Within half an hour, the cycling reaction can amplify the target sequence up to  $10^9$  copies. The final products are stem-loop DNAs that contain inverted repeats, cauliflower-like shapes with multiple loops made by annealing between alternative inverted repeats in the same strand of the target (**Figure 1**).

Owing to the unique structure produced by LAMP, visualization of the product can occur. Although traditional methods like ethidium bromide staining would reveal a distribution of products, (**Figure 2**), all that is really required is a visual confirmation that amplification occurred. This can be achieved visually by precipitation of magnesium pyrophosphate or the addition of polyethylenimine [7]. Alternately, incubation with the dye SYBR green I will provide a color change when amplification occurs (**Figure 3**).



**Figure 2.** Ethidium bromide used to visualize LAMP product distribution.



**Figure 3.** Visible indication that LAMP was successful.

Background on chemical heating. In order to provide the thermal energy in the absence of electricity, the P3 project will assess the use of chemical heating. There are a variety of exothermic reactions that can be employed to provide heat to drive LAMP that encompass something as simple as the chemistry of iron oxidation or the dissolution of supersaturated solutions. With regard to the former, heat is released as a consequence of finely divided iron powder being exposed to air, whereas in the latter a solution of sodium acetate is forced to crystallize. Both methods can produce the heat necessary for LAMP but suffer minor drawbacks. Iron powder heating produces a waste product that only can be used once, whereas the supersaturated solution can be reused provided a source of boiling water is available.

Chemical heating has been proposed as a source of heat for PCR-based methods within the last two years [8,9], and have shown promise. However, these investigations stopped well short of

developing a technology that can be packaged into a small format.

Choice of model water-borne infectious agents. The P3 project will investigate the utility of LAMP in water quality assessment by testing for DNA of two common pathogens, The first, *Giardia intestinalis*, is a flagellated protozoan with a very wide host range. Usually less than 10 cysts can cause giardiasis, and a single human stool sample can contain 300 million cysts.

Treatment of water by chlorine or other purifying chemicals does not destroy the cysts, so water is generally filtered to remove the cysts. Detection of cyst or trophozoite stage by microscope is time-consuming and suffers from poor detection. A LAMP based detection system would seek a combination of five conserved genes to detect *Giardia lamblia* in different samples [10]. The genes are small subunit ribosomal RNA (ssu-rRNA),  $\beta$ -giardin (bg), triose phosphate isomerase (tpi). Glutamate dehydrogenase (gdh), or EF1 $\alpha$ . The majority of previous research is on the EF1 $\alpha$  gene. Using the LAMP technique, we can detect the *Giardia lamblia* directly from water sample and we don't need any pre LAMP preparation, just extracted DNA.

The second pathogen will be *Shigella flexneri* and EIEC, for they are common bacterial water borne disease in developing countries [11]. They can cause severe dehydration and death, especially in young children and immunocompromised people. Detection by culture method takes many days and may difficult to distinguish from other normal bacteria. A LAMP method to detect *Shigella* targets the ipaH gene. Fortunately, the ipaH gene is also carried by enteroinvasive *E. coli* (EIEC). Subsequently, we can use this gene as a target for both bacteria.

### **Research Description**

The three major research thrusts of Phase I lead to a demonstration of the detection platform and are based on the challenges (LAMP, heating, and visualization). Data will be necessary to develop design specifications for Phase II, leading to a device similar to that shown in **Figure 4**.

Figure 4 is a device produced by NowDiagnostics (NowDx), a company in close proximity to the

UA. The device is a point-of-care, single use assay. Sample enters one end of the device, is drawn into various chambers via capillary action, and visualization occurs at the opposite end.

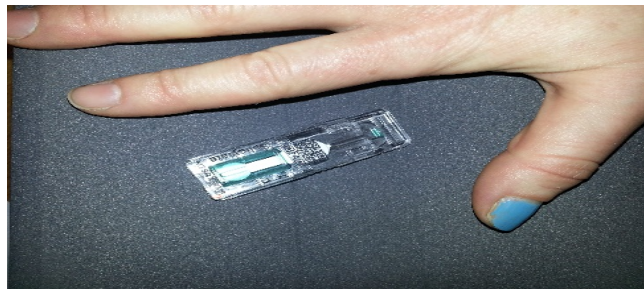
LAMP. Two primer sets for the model water-borne agents will be designed for each of the aforementioned genes. In order to design a primer set the sequence of DNA for a gene will be acquired from literature, NCBI in particular, and used as input for open source software

(<http://primerexplorer.jp/e/>). DNA primers will be purchased from Integrated DNA

Technologies (Coralville IA), and BSt polymerase and PCR reagents will be obtained from New England Biolabs (Ipswich MA). DNA for the model water-borne agents can be obtained from ATCC (Manassas VA). As mentioned previously, we will work with the DNA of the infectious agent and not culture the pathogens.

Students will be required to investigate the following: ratio of DNA to primer, temperature, time, and concentration of enzyme. Initially, these investigations are carried out in a benchtop thermocycler as the second part of the team develop the chemical heating protocols for the effort.

At the end of this part of the effort, the students will be able to provide information on the optimal conditions for LAMP, as well as describing the variable space that may be (re)visited should a change be required as the project proceeds. Returning to **Figure 4** indicates that the target volume for the LAMP would be about 100 uL maximum, which will be used as a design constraint.



**Figure 4.** NowDx assay for salicylic acid.

As mentioned previously, oxidation of iron and sodium acetate crystallization will be investigated as possible methods of heating. It is anticipated that each reaction can provide the amount of heat required to drive a small volume PCR reaction, with this material residing in a small reservoir on the backside of the device. Students will determine, for the case of iron oxide, the heat released per gram metal, the effect of particle size on rate of heat generation, and finally, the type of insulation surrounding the material. It is anticipated that iron oxidation will be the preferred chemistry because of its simplicity, in contrast to sodium acetate crystallization. Crystallization will require a reservoir to contain a supersaturated solution and a small, rough surface element used as a nucleation catalyst. This chemistry is feasible to use, but will be decidedly more difficult to miniaturize. Nevertheless, and if required, students will investigate the use of different supersaturated solutions (type and concentration), volume of solution, and roughness element surface area.

Visualization. Students will investigate the use of SYBR green I or similar dye to report on the progress of a LAMP reaction. They will determine the relationship between positive visual result and the following: concentration dye, amount of DNA from LAMP reaction, and the threshold volume required for positive detection.

### **Relationship of Challenge to Sustainability (People, Prosperity and the Planet)**

#### **People**

The proposed water quality monitoring system will demonstrate the ability to detect Giardia, Shigella, and E. coli via LAMP. These diseases are prominent worldwide, and are encountered both in developed and developing countries. It is anticipated, should Phase II be completed, a device similar to a home pregnancy “dip stick” will be constructed that is small and easily read.

#### **Prosperity**

In Bamako, the capital of Mali, it is estimated that poor people pay 45 times more for clean



water than the rich, since the rich get it subsidized and piped into their houses [26]. Further a study in Lebanon in 2003 found that lack of access to clean water leads directly to a lack of productivity as high as >3% gross domestic product [27]. Thus, the ability to quickly assess water quality will aid in providing clean, simple access to purified water will increase the quality of life, decrease the costs, and increase the overall productivity of a large section of the world.

### **Planet**

By 2050 the UN predicts that 85% of the global population will live in developing nations [17]. Additionally a Nature review article shows that many of the infectious diseases re-emerging and leading to deaths around the world are in developing nations where much of the problem can be attributed to unsanitary conditions [28]. Thus, it is reasonable to assume that the population shift to developing nations will cause an even greater impact on the developing and developed world if inexpensive sources of clean water are not identified and water quality is not monitored. The proposed approach attempts to provide advanced monitoring techniques for water purification.

### **Educational and Interdisciplinary Aspects**

The team will include 5 engineering students, with the program available to students in chemical, biomedical, or biological engineering. Students will be able to use the project as a basis for their capstone engineering project, typically credited as (Honors) Senior Design. For example, the chemical engineering students will be given course credit for Honors Design II (with the option to use this project for their Honors thesis); similar mechanisms exist in all three departments.

Note that Professors Beitle and Hestekin are Affiliated Faculty in the Bioengineering Department at the UA, and Beitle is Adjunct Faculty in Biological Engineering. The cross-disciplinary appointments allow Hestekin and Beitle to advise students in these programs.

In addition to providing a learning experience for the 5 undergraduate students, this project

also has educational benefits for K-12 students. Several times a year rising high school juniors and seniors visit the College of Engineering to explore chemical, biomedical, and biological engineering through a week-long summer camp. If this project is funded, a learning module for these camps will be developed by Professors Hestekin and Beitle, who routinely participate in camp planning. Similarly, an advanced version of the module will be made available to each department and used in biochemical / biomolecular engineering course offerings.

The University of Arkansas Department of Chemical Engineering, has participated in the WERC International Environmental Design Competition held at Las Cruces, New Mexico, each spring for the past 11 years as part of the undergraduate design course. Further, the University of Arkansas has participated in 3 successful EPA P3 Phase I proposals, two of which were honorable mentions for Phase II. We anticipate that most of the students who participate in the P3 competition, including the student leaders, will be members of the University of Arkansas Honors College, and all of the students in chemical engineering will be enrolled in the capstone senior design course sequence in the chemical engineering curriculum.

### **Results (Outputs/Outcomes), Evaluation and Demonstration**

#### **Societal, Economic, and Environmental Benefits**

The most significant result of this project will be the schematics for a LAMP based detection system, illustrating its potential to quickly and cheaply assess the presence of two challenge water-borne agents (*Giardia lamblia* and *Shigella dysentery*). With a description of the chemistry, heating, and visualization requirements in hand, Phase II can proceed by developing the packaging necessary for a self-contained water quality measuring device. During Phase II, it is anticipated that the UA will partner with NowDx, a local biotechnology-based company vested in point-of-care technology. The device format of NowDx can be adapted to provide a LAMP PCR platform due to the ability to (re)design and 3D-print working prototypes quickly. The owner of NowDx is an alumni of the University of Arkansas and has permitted students to

intern at his facility. He has also granted Professor Beitle a sabbatical in the past, indicating a high degree of cooperation with the UA. At the completion of Phase II and with several platforms in hand, the UA teams that visit Belize will be given the technology for field testing.

### **Transferability/Scalability**

At completion of Phase I, the knowledge gained can form the basis for a Phase II application. Successful completion of Phase II would permit the UA and NowDx to continue device development through SBIR/STTR application, or application to the Gates Foundation Grand Challenge program.

### **Success Criteria**

- Primers will be designed to detect two different pathogens using LAMP. The primer design will be considered successful if it allows consistent and repeatable detection of the pathogens in a sample where pathogen DNA is present (5/5 times) and does not detect pathogen in a sample with no pathogen DNA present (5/5 times).
- A chemically based heating system will be designed and optimized based on amount of reactants (grams), size of reactant particles, and insulating material. The heating system will be considered successful if it can successfully produce the required heat in 3 consistent reactions and can be used to successfully run a LAMP reaction in 3 consistent reactions.
- A visualization method will be developed for its robust ability to detect over a range of possible DNA concentration with a minimal amount of dye required. The visualization system will be considered a success if DNA can be successfully visualized at 3 different concentrations with three replicated (3 concentrations X 3 repeats = 6 analyses).
- If time allows, the complete heating and visualization system will be tested as an integrated unit for its ability to successfully detect a pathogen using LAMP.

## **Project Schedule, Milestones, and Management**

### **Project Schedule and Milestones**

Fall 2015 will be used to identify the students and begin planning. The project schedule for Spring 2016 is outlined in **Figure 5** with a detailed description provided in the text below. The Summer of 2016 will be used by the PI and co-PI's to discuss with companies the potential of the final design and prepare, submit a journal article(s), and work with NowDx.

#### Task 1: Literature Review (Month 0-1)

Students will perform this literature review on LAMP, low technology heating methods, and visual detection reactions.

#### Task 2: Primer design (Month 1-4)

Task 2.1: Students will use NCBI to determine the sequenced regions of the model pathogens and design potential primers ( $\geq 2$  sets). (Month 1)

Task 2.2: Students will test potential primers using LAMP on ATCC DNA to determine which primers provide the best amplification as assessed by spectroscopic quantitation of product DNA. (Month 2-3)

- Milestone: Successful selecting of a primer set for each pathogen capable of being used in LAMP.

#### Task 3: Low technology heating method (Month 1-4)

Task 3.1: Test amount of heat produced per gram of reaction materials. (Month 1)

Task 3.2: Test effect of particle size on amount of heat produced in reaction (Month 2)

Task 3.3: Test effect of insulating material on amount of heat transferred from reaction. (Month 3-4)

- Milestone: Chemical reaction conditions (amount of material and particle size) and insulating material identified to meet requirements of LAMP reaction.

#### Task 4: Visualization (Month 1-4)

Task 4.1: Test amount of DNA required for positive visual DNA detection using SYBR green I and at least 2 other dyes (Month 1)

Task 4.2: Test dilutions of most sensitive dye to determine minimum dye required for positive detection (Month 2)

Task 4.3: Determine threshold volume required for positive visual detection (Month 3)

Task 4.4: Evaluate robustness of visualization dye over range of possible DNA concentrations and volumes

- Milestone: Optimum visualization dye identified in terms of minimal amount and robustness

#### Task 5: Report (Month 4-5)

Students will prepare both an engineering and economic evaluation of the method. A final report will be turned into the EPA by the deadline.

- Milestone: Submit final report

#### Task 6: National Expo (Month 6)

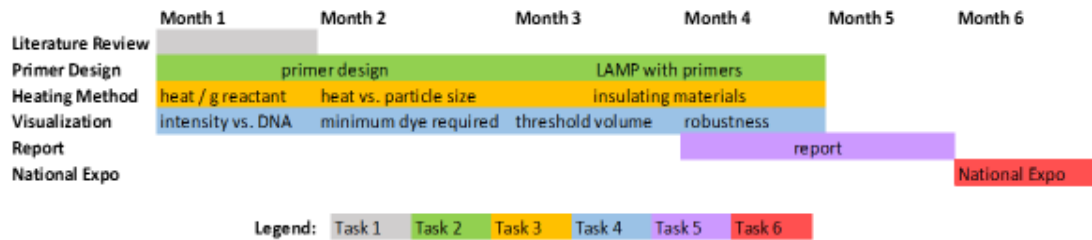
The full student team will travel to the National Expo for presentation. The presentation will include a working demonstration that shows the ability to visually detect pathogen DNA without the use of electricity or equipment.

- Milestone: Participate in design expo

### **Project Management**

Drs. Beitle and Hestekin will oversee the project, and Ph.D. candidate Ahmed Elmasheiti will provide technical assistance to the students when needed. Both faculties have management experience for state and federal projects involving multiple investigators, and will insure the

project is completed in the appropriate timeframe. Professor Beitle will be the primary point-of-contact for daily troubleshooting, and both professors will be involved in weekly planning/update meetings with students. Owing to her past experience with P3 teams, Professor Hestekin will oversee QA/QC and data management. Where appropriate, replication will be decided upon prior to start of an experiment, and replicates will be performed accordingly. Good laboratory notebook practice will be discussed with the students, and during the course of the project, laboratory notebooks will be signed off by one of the faculty advisors. Data will be kept on student computers as well as faculty computers. Finally, Elmasheiti will assist in the training of the students in various aspects of molecular biology necessary for rapid progression of the experimental program.



## References

- [1] Annan, K. United Nations Press Release.  
[www.un.org/News/Press/docs/2003/sgsm8707.doc.htm](http://www.un.org/News/Press/docs/2003/sgsm8707.doc.htm) 2003.
- [2] Natural Resources Defense Council Press Release.  
<http://www.nrdc.org/legislation/hk/execsum.asp> 2014.
- [3] Notomi H, et al. Nucleic Acids Research (2000) **28**, e63.
- [4] Parida M, et al. Review of Medical Virology (2008) Published online in Wiley InterScience  
([www.interscience.wiley.com](http://www.interscience.wiley.com)) doi: 10.1002/rmv.593.
- [5] Mori Y, et al. BMC Biotechnology (2006) **6**, 3.
- [6] Griffin H, Griffin A. PCR Technology (1994) Published online by OMICSGroup, 228.
- [7] Hodo H, Blatti S. Biochemistry (1977) **16**, 2334.
- [8] Harwkins K, et al. PLOS (2011) doi 10.1371/journal.pone.0019738.
- [9] Weigl B, et al. Expert Rev Medical Devices (2009) **6**, 461.
- [10] National Center for Biotechnology Information.  
<http://www.ncbi.nlm.nih.gov/pmc/articles/PMC3662070>
- [11] Kotloff K, et al. Bulletin of the World Health Organization (1999) **77**, 651.

## Budget Justification

### Travel

Purpose of Travel	Location	Item	Computation	Cost
EPA STAR Progress Review	DC	Airfare	5 people x \$400	\$2,000
		Lodging	3 rooms x \$200 per night x 3 nights	\$1,800
		Ground Transportation	Taxis	\$100
		Per Diem	\$71/day x 5 people x 3 days	\$1,065
Total Travel				\$4,965

### **Materials and Supplies**

A request of \$5200 is made to support the project. This money will support the purchase of LAMP DNA primer sets for two water-borne pathogens (\$450) and enzymes/nucleotides for PCR amplification (\$3000). The remainder (\$1750) of the request shall be used to purchase consumables (gloves, glassware, pipettes and pipette tips).

### **Facilities and Administrative Costs**

47% of MTDC in accordance with F&A Rate Agreement approved by DHHS, effective 07/01/15 – 06/30/16.